

**User Guide**

**50" LED TV**

**SHARP®**

**LC-50LB150U**

**Before using your new product, please read these instructions to prevent any damage.**

# SHARP®

## Contents

---

CHILD SAFETY .....	1
Important Safety Instructions .....	2
WARNING .....	2
CAUTION .....	3
Introduction .....	4
MHL™ .....	4
CEC Control .....	4
Motion Enhancement .....	4
DTS Sound™ .....	4
Game mode .....	4
Installing the stand or wall-mount bracket .....	5
Installing the stand .....	5
Installing a wall-mount bracket .....	7
TV components .....	9
Package contents .....	9
Front .....	9
Side .....	10
Back .....	11
Remote control .....	12
What connection should I use? .....	13
Connecting a cable or satellite box .....	14
Using HDMI (best) .....	14
Using DVI (same as HDMI but requires an audio connection) .....	15
Using component video (better) .....	16
Using composite video (good) .....	17
Using coaxial (good) .....	18
Connecting an antenna or cable TV (no box) .....	19
Connecting a DVD or Blu-ray player .....	20
Using HDMI (best) .....	20
Using DVI (same as HDMI but requires an audio connection) .....	21
Using component video (better) .....	22
Using composite video (good) .....	23
Connecting an MHL-enabled device .....	24
Connecting a game console .....	25
Using HDMI (best) .....	25
Using component video (better) .....	26
Using composite video (good) .....	27

- Connecting a computer ..... 28
  - Using VGA (most common) ..... 28
  - Using HDMI (best) ..... 29
  - Using DVI (same as HDMI but requires an audio connection) ..... 30
- Connecting a USB flash drive ..... 31
- Connecting headphones ..... 32
- Connecting a basic home theater system ..... 33
  - Using digital audio ..... 33
  - Using analog audio ..... 34
- Connecting a home theater system with multiple devices ..... 35
- Connecting power ..... 36
- Using the remote control ..... 37
  - Installing remote control batteries ..... 37
  - Aiming the remote control ..... 37
- Turning on your TV for the first time ..... 38
- Understanding the basics ..... 40
  - Turning your TV on or off ..... 40
  - Selecting the video input source ..... 40
  - On-screen menu overview ..... 41
  - Navigating the menus ..... 41
  - Selecting a channel ..... 42
  - Adjusting the volume ..... 42
  - Viewing channel information ..... 42
- Adjusting the picture ..... 43
  - Adjusting the TV picture ..... 43
  - Setting the power on picture mode ..... 44
  - Adjusting the computer image ..... 45
- Adjusting the sound ..... 45
  - Adjusting sound settings ..... 45
  - Selecting the audio out mode ..... 46
  - Playing TV audio only ..... 47
- Changing channel settings ..... 47
  - Automatically scanning for channels ..... 47
  - Hiding channels ..... 49
  - Setting up a favorite channel list ..... 49
  - Viewing a favorite channel ..... 49
  - Adding or changing a channel label ..... 50
  - Checking the digital signal strength ..... 50
  - Automatically adjusting the aspect ratio ..... 51
- Setting parental controls ..... 51
  - Setting or changing the password ..... 51
  - Locking control buttons ..... 52
  - Blocking unrated TV ..... 52
  - Setting parental control levels ..... 53
  - Downloading rating information ..... 54

Using closed captioning .....	55
Turning closed captioning on or off .....	55
Selecting the analog closed captioning mode .....	56
Selecting the digital closed captioning mode .....	56
Customizing digital closed captioning settings .....	57
Adjusting time settings .....	58
Setting the clock .....	58
Setting the sleep timer .....	59
Adjusting menu settings .....	59
Selecting the menu language .....	59
Turning Input Sensor on or off .....	59
Labeling an input source .....	60
Using CEC Control .....	60
Turning CEC Control on or off .....	60
Turning Device Auto Power Off on or off .....	61
Turning TV Auto Power On on or off .....	61
Turning Audio Return Channel on or off .....	62
Displaying a list of CEC-compatible devices .....	62
Waking CEC-compatible devices .....	63
Opening a CEC-compatible device's root menu .....	63
Using an MHL-enabled device or Roku Streaming Stick .....	64
Using an MHL-enabled device .....	64
Using a Roku Streaming Stick .....	65
Using a USB flash drive .....	66
Switching to USB mode .....	66
Browsing photos .....	66
Viewing favorite photos .....	67
Viewing photos in a slideshow .....	67
Customizing slideshow settings .....	68
Maintaining .....	68
Cleaning the TV cabinet .....	68
Cleaning the TV screen .....	68
Troubleshooting .....	69
Restoring settings to the defaults .....	69
Viewing system information .....	69
Video and audio .....	70
Remote control .....	72
General .....	72
MHL-enabled device or Roku Streaming Stick .....	73
CEC-compatible device .....	74
Specifications .....	76
Programming universal remote controls .....	77
Common universal remote control codes .....	77
Legal notices .....	78
One-year limited warranty - Sharp Televisions .....	79



# CHILD SAFETY

## It makes a difference how and where you use your flat panel display

### As you enjoy your new product, keep these safety tips in mind

#### The issue

The home theater entertainment experience is a growing trend, and larger TVs are popular purchases. However, TVs are not always supported on the proper stands or installed according to the manufacturer's recommendations. We and the consumer electronics industry are committed to making home entertainment enjoyable and safe.

*TVs that are inappropriately placed on dressers, bookcases, shelves, desks, speakers, chests, or carts may fall over and cause injury.*

#### Tune into safety

- One size of TV stand does **not** fit all. Use only a TV stand rated for the weight of your TV.
- Carefully read and understand all enclosed instructions for proper use of this product.
- Don't let children climb on or play with entertainment system furniture and TVs.
- Don't place TVs on furniture that can easily be used as steps, such as a crate or chest of drawers.
- Remember that children can become excited while watching a program, especially on a "larger-than-life" TV. Make sure that you place or install the TV where it cannot be pushed, pulled over, or knocked down.
- Make sure that you route all cords and cables so that they cannot be pulled or grabbed by curious children.



#### Wall mounting

If you decide to wall mount your TV, always remember:

- One size of wall mount does **not** fit all. Use only a wall mount rated for the weight of your TV and that has been recommended by this TV manufacturer, listed in this manual, or otherwise listed by an independent laboratory as suitable for your TV.
- Follow all instructions supplied by the TV and wall mount manufacturers.
- If you have any doubts about your ability to safely wall mount your TV, get help from a professional installer.
- Make sure that the wall where you are mounting the TV is appropriate. Some wall mounts are not designed to be mounted to walls backed with steel studs or cinder blocks. If you are unsure, ask a professional installer.
- TVs can be heavy. At least two people are required for safe wall mount installation.



# Important Safety Instructions



This symbol indicates that dangerous voltage constituting a risk of electric shock is present within your TV. This label is located on the back of your TV.



This symbol indicates that there are important operating and maintenance instructions in the literature accompanying your TV.

- 1 Read these instructions.
- 2 Keep these instructions.
- 3 Heed all warnings.
- 4 Follow all instructions.
- 5 Do not use this apparatus near water.
- 6 Clean only with dry cloth.
- 7 Do not block any ventilation openings. Install in accordance with the manufacturer's instructions.
- 8 Do not install near any heat sources such as radiators, heat registers, stoves, or other apparatus (including amplifiers) that produce heat.
- 9 Do not defeat the safety purpose of the polarized or grounding-type plug. A polarized plug has two blades with one wider than the other. A grounding type plug has two blades and a third grounding prong. The wide blade or the third prong are provided for your safety. If the provided plug does not fit into your outlet, consult an electrician for replacement of the obsolete outlet.
- 10 Protect the power cord from being walked on or pinched particularly at plugs, convenience receptacles, and the point where they exit from the apparatus.
- 11 Only use attachments/accessories specified by the manufacturer.
- 12 Use only with the cart, stand, tripod, bracket, or table specified by the manufacturer, or sold with the apparatus. When a cart is used, use caution when moving the cart/apparatus combination to avoid injury from tip-over.
- 13 Unplug this apparatus during lightning storms or when unused for long periods of time.



S3125A

- 14 Refer all servicing to qualified service personnel. Servicing is required when the apparatus has been damaged in any way, such as power-supply cord or plug is damaged, liquid has been spilled or objects have fallen into the apparatus, the apparatus has been exposed to rain or moisture, does not operate normally, or has been dropped.
- 15 The wall plug is the disconnecting device. The plug must remain readily operable.
- 16 Remote control batteries should not be exposed to excessive heat such as sunshine, fire, or the like.
- 17 The apparatus should not be exposed to dripping or splashing, and no objects filled with liquids, such as vases, should be placed on the apparatus.

## WARNING

### *Electric shock hazard*

To reduce the risk of fire or electric shock, do not remove any cover or expose the device to rain or moisture. No user-serviceable parts are inside. Refer servicing to qualified service technicians.

### *Lightning*

For added protection for your device receiver during a lightning storm, or when it is left unattended and unused for long periods of time, unplug it from the power outlet and disconnect any antenna or cable system. This helps prevent property damage and personal injury from lightning and power line surges.

### *Power lines*

An outside antenna system should not be located in the vicinity of overhead power lines or other electric light or power circuits, or where it can fall into such power lines or circuits. When installing an outside antenna system, take extreme care to keep from touching such power lines or circuits as contact with them might be fatal.

### *Handling the LCD panel*

- Your TV's screen is made of glass. Do not drop your TV or hit, jolt, or press hard against the LCD panel. If the screen breaks, be careful of broken glass.
- If the LCD panel is broken, make absolutely sure that you do not touch the liquid in the panel. This may cause skin inflammation.
- If the liquid gets in your mouth, immediately gargle, rinse, and consult with your doctor. Also, if the liquid gets in your eyes or touches your skin, consult with your doctor after rinsing for at least 15 minutes or longer in clean water.

### *Replacement parts*

When replacement parts are required, make sure that the service technician uses replacement parts specified by the manufacturer that have the same characteristics as the original part. Unauthorized substitutions may result in fire, electric shock, personal injury, or other hazards.

**Safety check**

After completing any service or repair to this device, ask the service technician to perform routine safety checks to determine that your TV is in correct operating condition.

**Power source**

Operate your TV only from the type of power source indicated on the marking label. If you are not sure of the type of power supplied to your home, consult an electrician or your local power company.

**Servicing**

These servicing instructions are for use by qualified service personnel only. To reduce the risk of electric shock, do not perform any servicing other than that contained in the operating instructions unless you are qualified to do so.

**CAUTION**

**Damage requiring service**

Unplug this TV from the power outlet and refer servicing to qualified service personnel under the following conditions:

- When the power supply cord or plug is damaged or frayed.
- If liquid has been spilled or objects have fallen into your TV.
- If your TV has been exposed to rain or water.
- If your TV does not operate normally by following the operating instructions. Adjust only those controls covered by the operating instructions because incorrect adjustment of other controls may result in damage and will often require extensive work by a qualified technician to restore your TV to its normal operation.
- If your TV has been dropped or damaged in any way.
- When your TV exhibits a distinct change in performance.

**Outdoor antenna grounding**

If an outside antenna or cable system is connected to your TV, make sure that the antenna or cable system is grounded to provide some protection against voltage surges and built-up static charges. Article 810 of the National Electrical Code, ANSI/NFPA No. 70, provides information with respect to correct grounding of the mast and supporting structure, grounding of the lead-in wire to an antenna discharge unit, size of grounding conductors, location of the antenna-discharge unit, connection to grounding electrodes, and requirements for the grounding electrode.

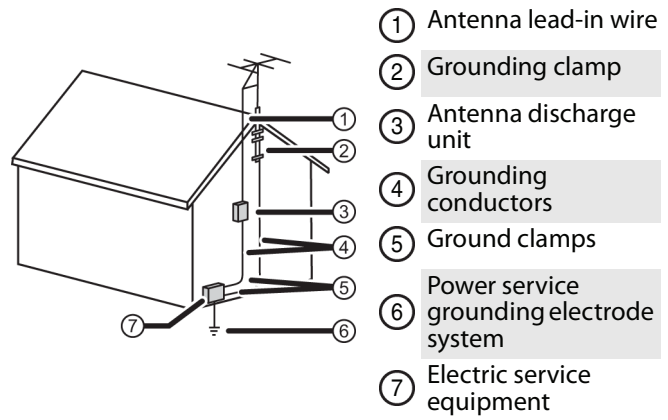

**Note to CATV system installer**

Article 820 of the National Electrical Code, ANSI/NFPA No. 40 provides guidance for correct grounding. Specifically, it states that the cable ground must be connected to the grounding system of the building as close to the point of cable entry as practical.

**Condensation**

Moisture will form on the TV if the TV is brought from cool surroundings into a warm room or if the temperature of the room rises suddenly. When this happens, the TV's performance may be impaired. To prevent this, let the TV stand in its new surroundings for about an hour before switching it on, or make sure that the room temperature rises gradually.

Condensation may also form during the summer if the TV is exposed to the breeze from an air conditioner. In such cases, change the location of the TV.

**Mobile telephone warning**

To avoid interference with your TV picture and sound, operating problems, or even damage, keep your cordless and cellular telephones away from the TV.

**End of life directives**

Your TV may contain materials that are regulated for environmental reasons. Your TV also contains materials that can be recycled and reused. To help protect the environment, contact your local authorities for information about disposal or recycling and about finding a recycler in your area before you dispose of your TV.

**Non-active pixels**

The LCD panel contains almost 3 million thin film transistors, which provide exceptionally sharp video quality. Occasionally, a few non-active pixels may appear on the screen as a fixed blue, green, or red point. These non-active pixels do not adversely affect the performance of your TV, and are not considered defects.



---

# Sharp 50" LED TV

---

## Introduction

Congratulations on your purchase of a high-quality Sharp product. Your LC-50LB150U represents the state of the art in LED TV design and is designed for reliable and trouble-free performance.

### MHL™

Connect your MHL-enabled device, such as a cell phone or Roku Streaming Stick™, and view your device's screen on your TV. Supports 1080p HD video and 5.1 digital surround sound playback from your mobile device. (Requires an MHL-enabled phone or tablet and an MHL cable.) (See page 24 for connection instructions.)

### CEC Control

Enjoy the benefit of having HDMI CEC compatible products plug and play! No setup is needed! CEC technology lets different components discover and communicate with each other. (See page 60 for instructions on how to use CEC Control.)

## Motion Enhancement

With a 120 Hz screen refresh rate twice the rate of a 60 Hz screen, a screen with 1,080 lines of resolution (up from 720 lines in the last generation of HDTVs), and special motion-detection technology, you will experience a picture with clearer detail and brightness, smoother transitions, and reduced motion blurring, particularly when watching fast-motion sports and action scenes. (See the **Motion Enhancement** option in "[Adjusting the TV picture](#)" on page 43 for instructions on how to adjust the TV picture.)

## DTS Sound™

DTS Sound delivers clear, crisp, and natural sound while providing deep enveloping bass.

## Game mode

Video games generally require adjustments to the television picture settings to get the maximum experience. By simply pressing a button on your remote control, your television settings will automatically adjust for video games. It couldn't be easier. (See the **Game** option in "[Adjusting the TV picture](#)" on page 43 for instructions on how to select Game mode.)

# Installing the stand or wall-mount bracket

## Notes

- If you plan to wall-mount your TV, do not install the stand.
- Store the stand and stand screws in case you decide to use the stand in the future.

## Installing the stand

### To install the stand:

- 1 Secure the stand column to the TV stand using the four provided M6 (12 mm) screws. (These are the long screws.)

Screw type	Screw length	# of screws
M6	12 mm	4

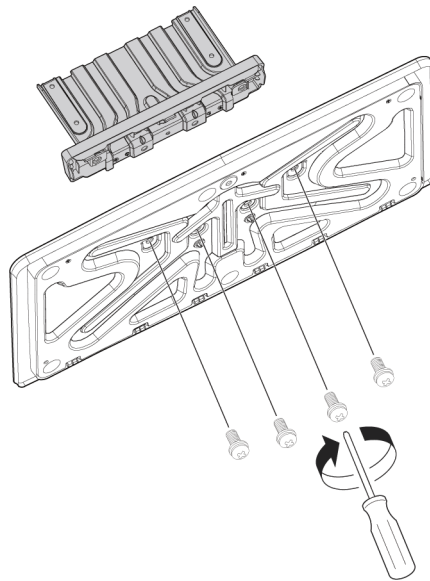

- 2 Carefully place your TV face-down on a cushioned, clean surface to protect the screen from damages and scratches.

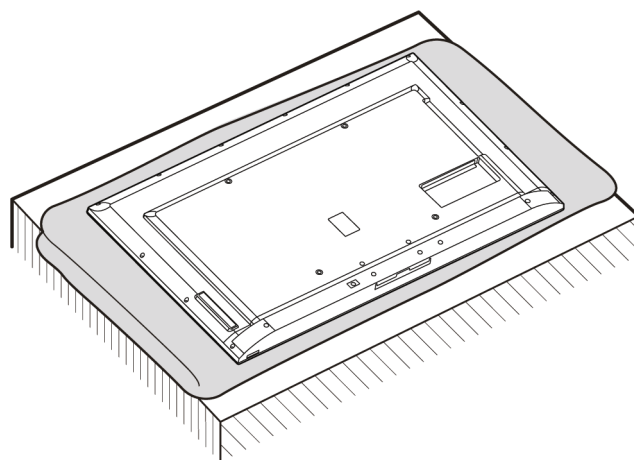

- 3 Insert the stand column into the TV.

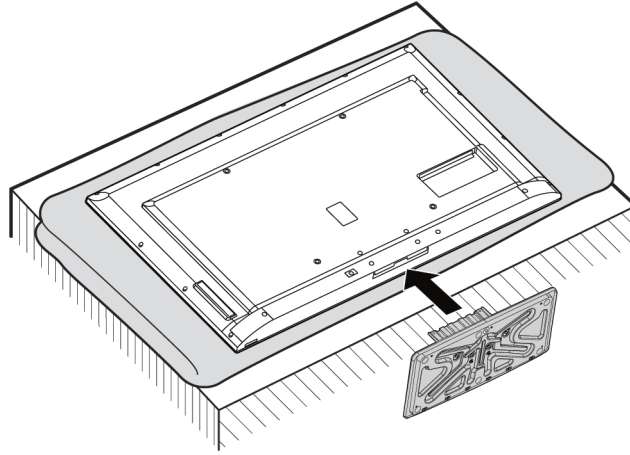

- 4 Secure the TV stand to your TV using the four provided M4 (8 mm) screws. (These are the short screws.)

Screw type	Screw length	# of screws
M4	8 mm	4

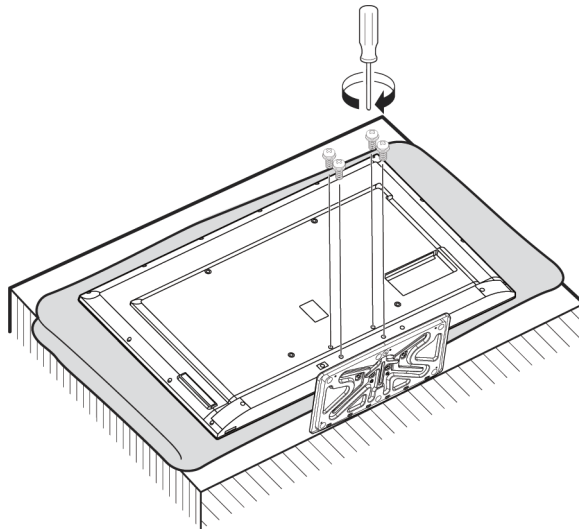

## Installing a wall-mount bracket

**Warning**

- This TV is intended to be supported by a UL Listed wall mount bracket with suitable weight/load. (See "Miscellaneous" on page 76.)
- To prevent injury, this apparatus must be securely attached to the floor/wall in accordance with the installation instructions.

**To attach your TV to a wall-mount bracket:**

- 1 Carefully place your TV face-down on a cushioned, clean surface to protect the screen from damages and scratches.

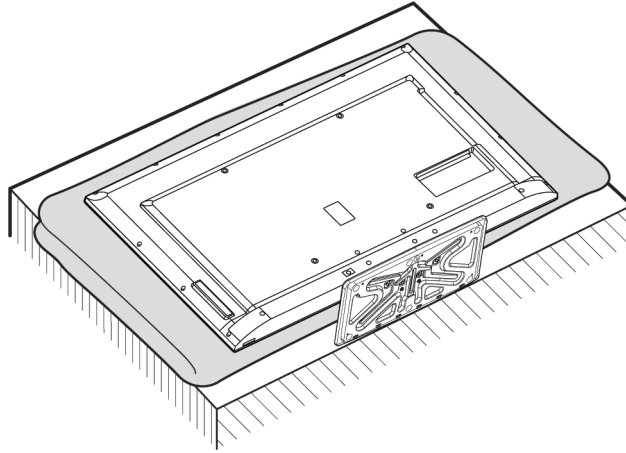

- 2 If the stand is attached, remove the four screws that secure the TV stand to your TV.

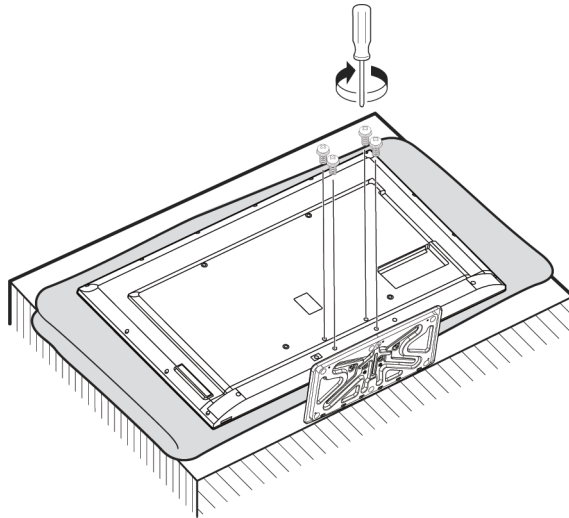

- 3 Remove the TV stand.

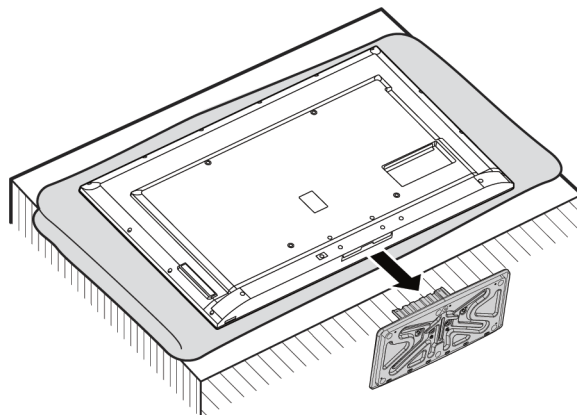

- 4 Remove the screws in the mounting holes on the back of your TV, then follow the instructions that came with the wall-mount bracket.

**Notes**

- The length of the wall-mount screws vary depending on the wall-mount bracket you purchased. See the instructions that came with the wall-mount bracket for screw lengths.
- The mounting holes on the back of your TV take type M6 screws.

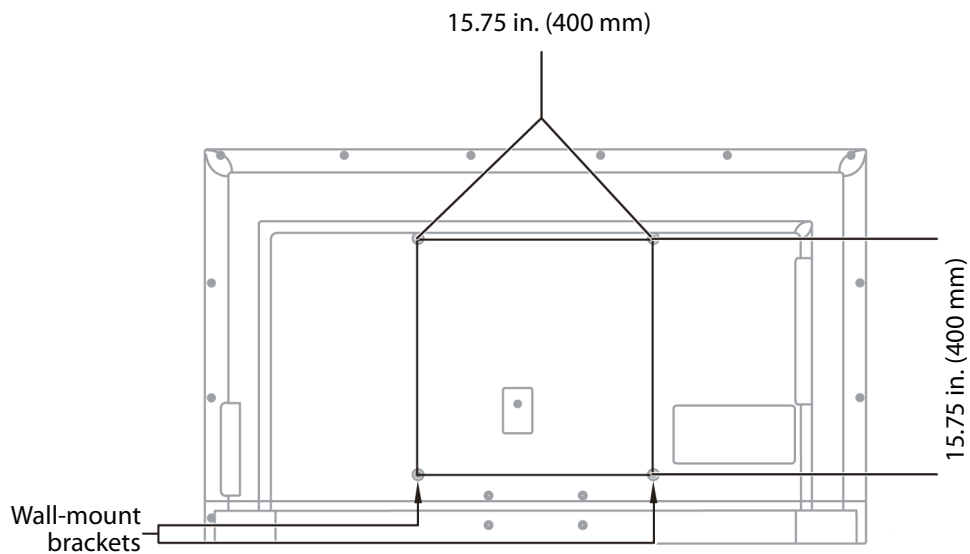

# TV components

## Package contents

- 50" LED TV
- Remote control and batteries (2 AAA)
- Stand column and screws (4)
- TV stand and screws (4)
- Power cord
- *Quick Setup Guide*
- *Important Information*

## Front

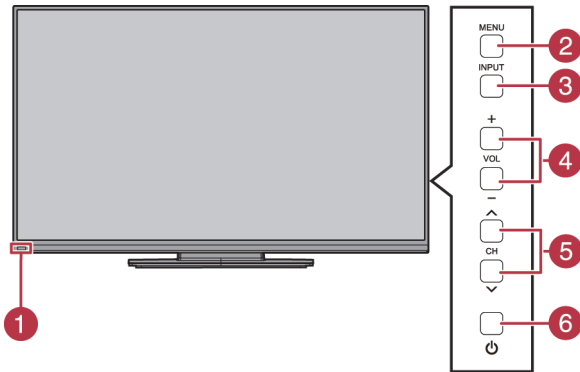

#	Item	Description
①	Remote control sensor and power indicator	The remote control sensor receives signals from the remote control. Do not block. The power indicator: <ul style="list-style-type: none"> <li>• Lights blue when your TV is on.</li> <li>• Lights red when your TV is off (standby mode).</li> </ul>
②	MENU	Press to open the on-screen menu. For more information, see <a href="#">"Navigating the menus"</a> on page 41.
③	INPUT	Press one or more times to select the video input source you want, then wait a few seconds. Your TV switches to the source you selected. For more information, see <a href="#">"Selecting the video input source"</a> on page 40. In menu mode, press to confirm selections.
④	VOL+/VOL-	Press to increase or decrease the volume.
⑤	CH ^/CH v	Press to go to the next or previous channel in the channel list. For more information, see <a href="#">"Selecting a channel"</a> on page 42.
⑥	⏻ (power)	Press to turn your TV on or off (standby mode). <b>Warning:</b> When your TV is off, power still flows through it. To completely disconnect power, unplug the power cord.

Side

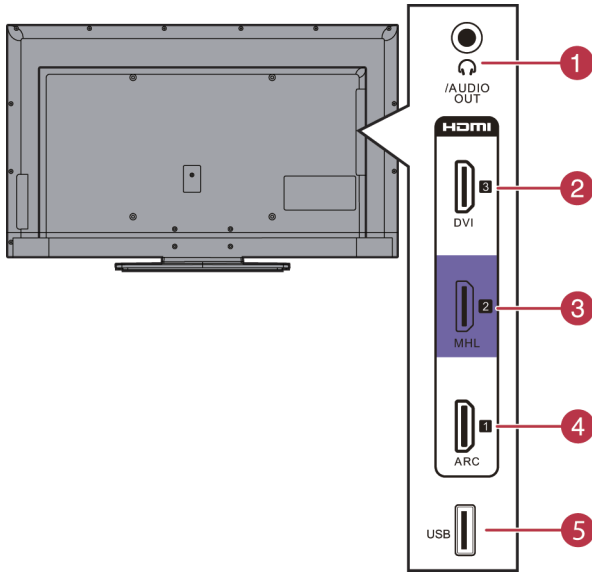

#	Item	Description
①	🎧 /AUDIO OUT	Connect headphones, an analog audio amplifier, a home theater system, or a sound bar to this jack. For more information, see "Connecting headphones" on page 32 or "Using analog audio" on page 34.
②	HDMI 3/DVI	Connect an HDMI device to this jack. For more information, see "Using HDMI (best)" on pages 14, 20, 25, or 29. OR Connect the video for a DVI device to this jack. For more information, see "Using DVI (same as HDMI but requires an audio connection)" on pages 15, 21, or 30.
③	HDMI 2/MHL	Connect an MHL-enabled device, such as a cell phone or Roku Streaming Stick™, to this jack to view pictures and videos stored on the device. For more information, see "Connecting an MHL-enabled device" on page 24 and "Using an MHL-enabled device or Roku Streaming Stick" on page 64.
④	HDMI 1/ARC	Connect an HDMI device to this jack. For more information, see "Using HDMI (best)" on pages 14, 20, 25, or 29. OR Connect a home theater that supports ARC to this jack.
⑤	USB	Connect a USB flash drive to this jack to view compatible JPEG picture files. For more information, see "Connecting a USB flash drive" on page 31 and "Using a USB flash drive" on page 66.

**Back**

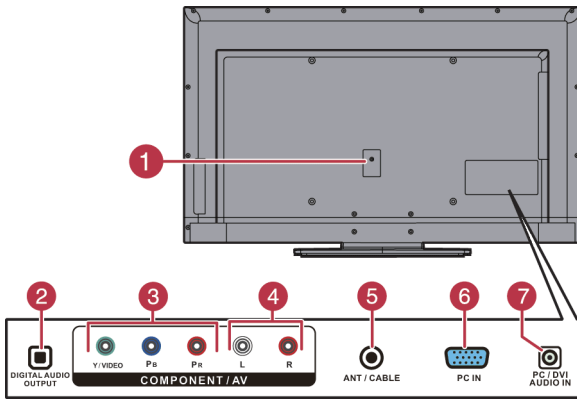

#	Item	Description
①	Power connector	Plug the power cord into this connector.
②	DIGITAL AUDIO OUTPUT (optical)	Connect a digital audio amplifier, a home theater system, or a sound bar to this jack to listen to TV audio through the external speakers. For more information, see "Using digital audio" on page 33.
③	COMPONENT/AV Y/VIDEO, Pb, Pr OR COMPONENT/AV Y/VIDEO	The <b>COMPONENT/AV Y/VIDEO</b> jack works as one of the three component video jacks or as a composite video jack. Connect the video for a component video device to these jacks. For more information, see "Using component video (better)" on page 16, 22, or 26. OR Connect the video for a composite video device to the <b>COMPONENT/AV Y/VIDEO</b> jack. For more information, see "Using composite video (good)" on page 17, 23, or 27.
④	L and R (audio)	Connect the audio for a component video device to these jacks. For more information, see "Using component video (better)" on page 16, 22, or 26. OR Connect the audio for a composite video device to these jacks. For more information, see "Using composite video (good)" on page 17, 23, or 27.
⑤	ANT/CABLE	Connect an antenna or cable TV to this jack. For more information, see "Using coaxial (good)" on page 18 or "Connecting an antenna or cable TV (no box)" on page 19.
⑥	PC IN	Connect the video (VGA) for a computer to this jack. For more information, see "Using VGA (most common)" on page 28.
⑦	PC/DVI AUDIO IN	Connect the audio for a computer to this jack. For more information see "Using VGA (most common)" on page 28. OR Connect the audio for a DVI device to this jack. For more information see, "Using DVI (same as HDMI but requires an audio connection)" on pages 15, 21, or 30.



### Remote control

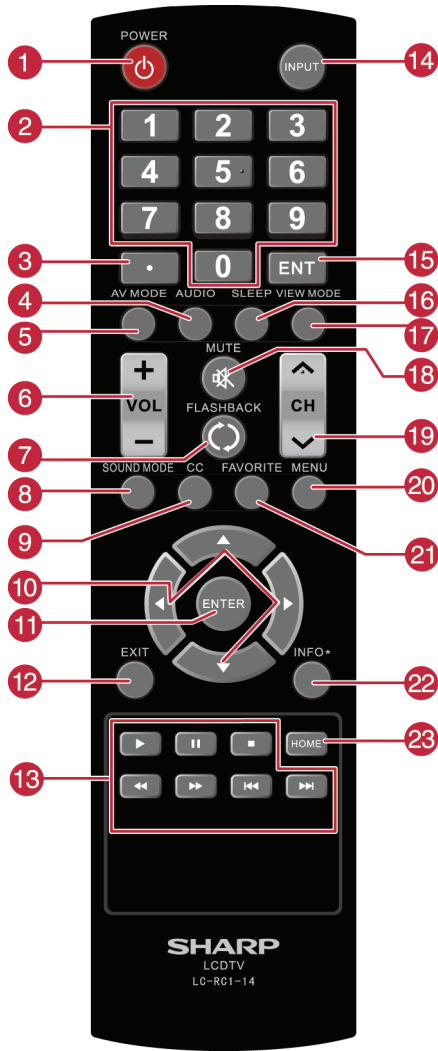



#	Button	Description
①	POWER	Press to turn your TV on or off (standby mode). <b>Warning:</b> When your TV is off, power still flows through it. To disconnect power, unplug the power cord.
②	Numbers	Press to enter channel numbers and the parental control password.
③	●	Press to enter a digital sub-channel number. For more information, see "Selecting a channel" on page 42.
④	AUDIO	Press to select the audio mode for an analog program. You can select: <ul style="list-style-type: none"> <li>• <b>Mono</b>—Select this option if there is noise or static on weak stereo broadcasts.</li> <li>• <b>Stereo</b>—Select this option for programs broadcast in stereo.</li> <li>• <b>SAP</b>—Select this option to listen to a secondary audio program, if available.</li> </ul> OR Press to select the audio language for a digital program, if alternate languages are available.
⑤	AV MODE	Press to select the AV (picture) mode. You can select <b>Dynamic, Natural, Standard, Movie, Game, or User.</b>
⑥	VOL+/-	Press to increase or decrease the volume.
⑦	FLASHBACK	In TV mode, press to return to the previous channel.

#	Button	Description
⑧	SOUND MODE	Press to select the sound mode. You can select <b>Standard, Movie, Music, Voice, or User.</b> For more information, see "Sound Mode" in "Adjusting sound settings" on page 45.
⑨	CC	Press to turn closed captioning on or off. You can select <b>Off, On Always or On When Mute.</b> For more information, see "Turning closed captioning on or off" on page 55.
⑩	▲ ▼ ◀ ▶	Press to navigate in on-screen menus and to adjust settings.
⑪	ENTER	Press to confirm selections or changes or to open sub-menus.
⑫	EXIT	Press to close the on-screen menu.
⑬	CEC controls	Press to control CEC devices connected to your TV. For more information, see "Using CEC Control" on page 60.
⑭	INPUT	Press to open the <i>INPUT SOURCE</i> list, press ▲ or ▼ on the remote control to select the video input source, then press <b>ENTER</b> . For more information, see "Selecting the video input source" on page 40.
⑮	ENT	Press to go to the channel you selected using the number buttons.
⑯	SLEEP	Press to set the sleep timer. You can select <b>Off, 5, 10, 15, 30, 60, 90, 120, 180, or 240</b> minutes. For more information, see "Setting the sleep timer" on page 59.
⑰	VIEW MODE	Press to change how the picture looks on the screen (aspect ratio). For more information, see the <b>View Mode</b> option in "Adjusting the TV picture" on page 43.
⑱	MUTE	Press to mute the sound. Press again to restore the sound.
⑲	CH ▲/CH ▼	Press to change TV channels. For more information, see "Selecting a channel" on page 42.
⑳	MENU	Press to open the on-screen menu.
㉑	FAVORITE	Press to open the <i>FAVORITES LIST</i> . For more information, see "Setting up a favorite channel list" on page 49 and "Viewing a favorite channel" on page 49.
㉒	INFO*	Press to display TV status information, such as the channel number, channel name (if available), or signal source. For more information, see "Viewing channel information" on page 42.
㉓	HOME	Opens the MHL device's home menu when an MHL device is plugged in. For more information, see "Using an MHL-enabled device or Roku Streaming Stick" on page 64.

# What connection should I use?

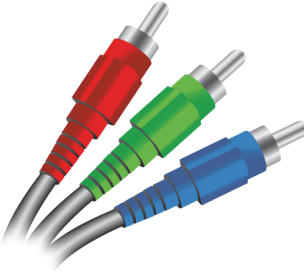
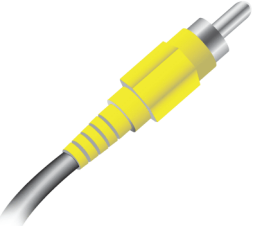
Your TV has several connection types for connecting devices to your TV. For the best video quality, you should connect a device to the best available connection. Use the following tables to identify cables:

Video quality	Connection type and jack	Cable connector
Best (use this if your devices have HDMI)	HDMI video/audio	
Better than composite or coaxial	Component video (requires an audio connection)	
Better than coaxial	Composite video (requires an audio connection)	
Good	Coaxial video/audio	

## Connection type and jack

### Optical digital audio



### Analog audio input

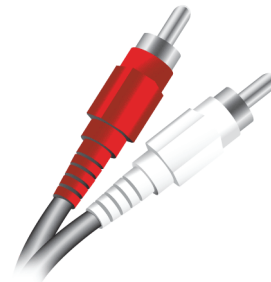

### Analog audio output



### VGA (computer) video and audio

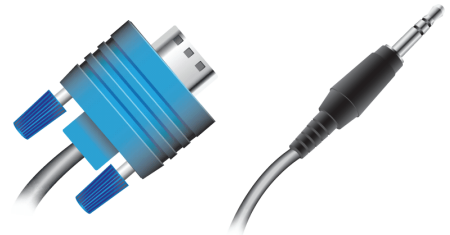
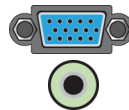

You can use the **HDMI 3/DVI** jack on your TV to connect a DVI device to your TV. You need to attach an HDMI-to-DVI adapter to the end of the HDMI cable that connects to the DVI device.

### Cautions

- Check the jacks for position and type before making any connections.
- Loose connections can result in image or color problems. Make sure that all connections are tight and secure.
- The external audio/video equipment shown may be different from your equipment. If you have questions, refer to the documentation that came with your equipment.
- Always unplug the power cord when connecting external equipment.

# Connecting a cable or satellite box

Many cable or satellite TV boxes have more than one connection type. To get the best video, you should use the best connection type available. For more information, see "What connection should I use?" on page 13.

## Using HDMI (best)

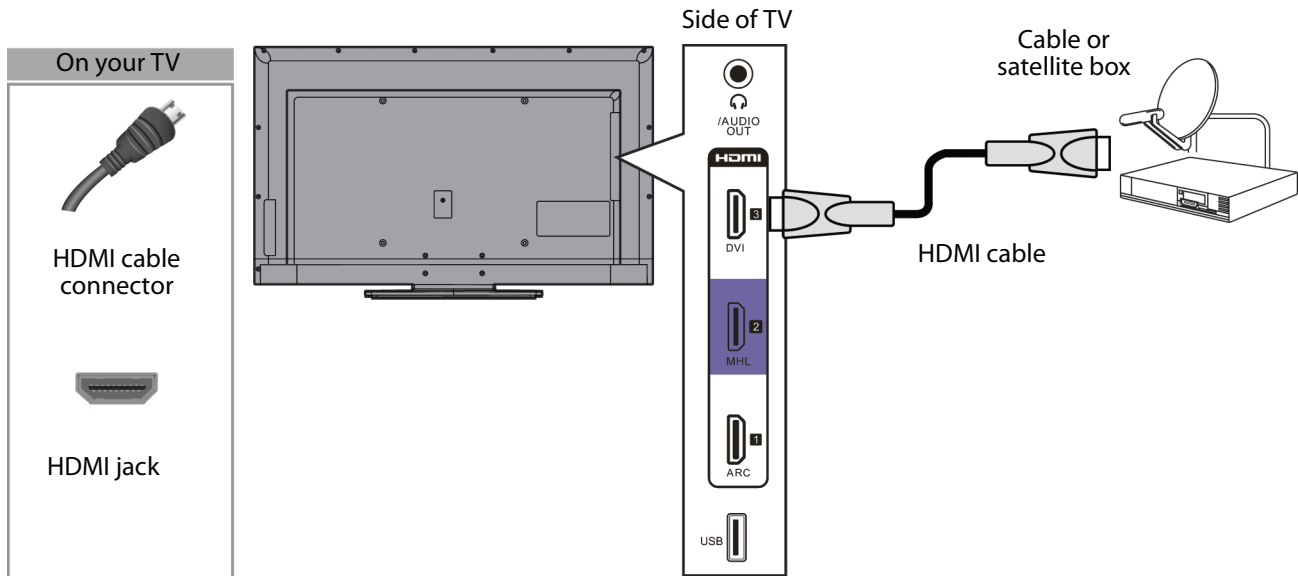

### To connect a cable or satellite box using HDMI:

- 1 Make sure that your TV's power cord is unplugged and all connected equipment is turned off.
- 2 Connect the incoming cable from the cable wall jack to the cable-in jack on the cable or satellite box.
- 3 Connect an HDMI cable (not provided) to one of the **HDMI** jacks on the side of your TV and to the **HDMI OUT** jack on the cable or satellite box.
- 4 Plug your TV's power cord into a power outlet, turn on your TV, then turn on the cable or satellite box.
- 5 Press **INPUT** to open the *INPUT SOURCE* list.
- 6 Press **▲** or **▼** to highlight **HDMI 1**, **HDMI 2**, or **HDMI 3**, then press **ENTER**.

#### Note

An HDMI cable carries both audio and video. You do not need to use any audio cables.

**Using DVI (same as HDMI but requires an audio connection)**

**Note**  
 You must use the **HDMI 3/DVI** jack to connect a cable or satellite box using DVI. If you use another HDMI jack, you will not hear sound from the TV speakers.

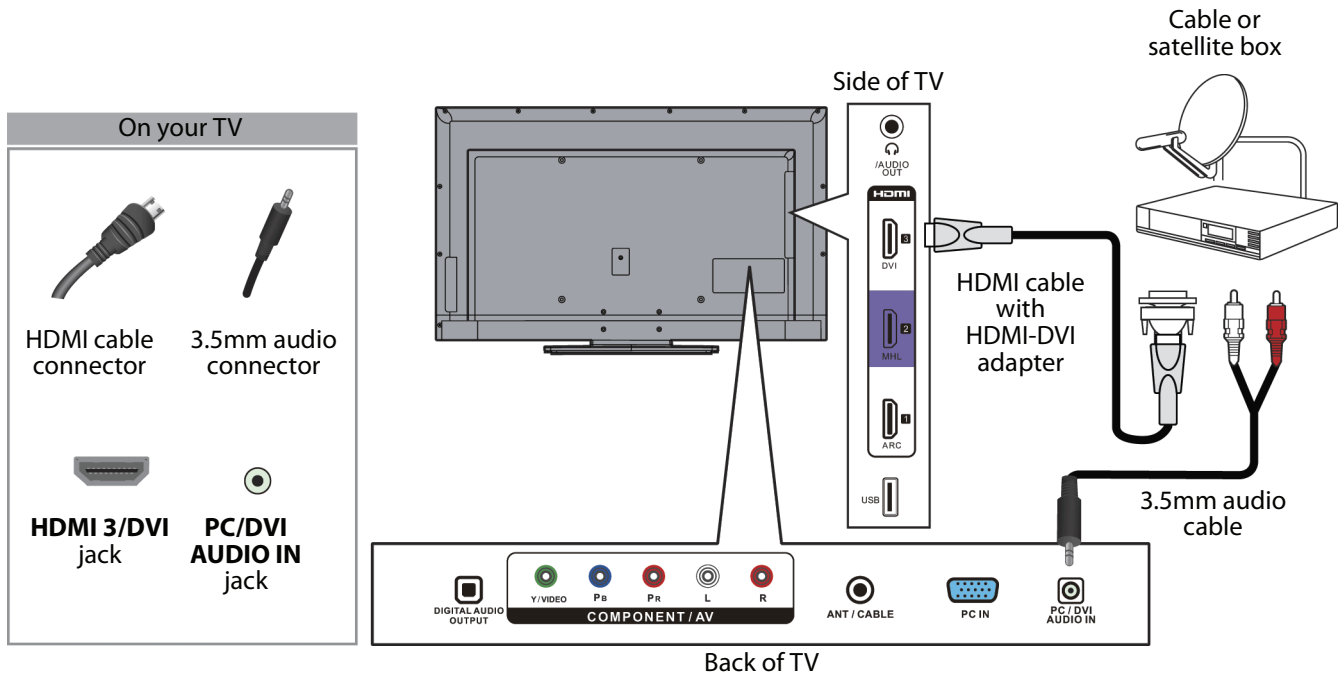

**To connect a cable or satellite box using DVI:**

- 1 Make sure that your TV's power cord is unplugged and all connected equipment is turned off.
- 2 Connect the incoming cable from the cable wall jack to the cable-in jack on the cable or satellite box.
- 3 Connect an HDMI-DVI adapter (not provided) to one end of an HDMI cable (not provided), then connect the adapter to the **DVI OUT** jack on the cable or satellite box.
- 4 Connect the other end of the cable to the **HDMI 3/DVI** jack on the side of your TV.
- 5 Connect a 3.5mm audio cable (not provided) to the **PC/DVI AUDIO IN** jack on the back of your TV and to the **AUDIO OUT** jacks on the cable or satellite box.

**Note**  
 When you connect the audio using the **PC/DVI AUDIO IN** jack, the audio output is analog.

- 6 Plug your TV's power cord into a power outlet, turn on your TV, then turn on the cable or satellite box.
- 7 Press **INPUT** to open the *INPUT SOURCE* list.
- 8 Press **▲** or **▼** to select **HDMI 3**, then press **ENTER**.

## Using component video (better)

**Note**  
Cables are often color-coded to match color-coded jacks.

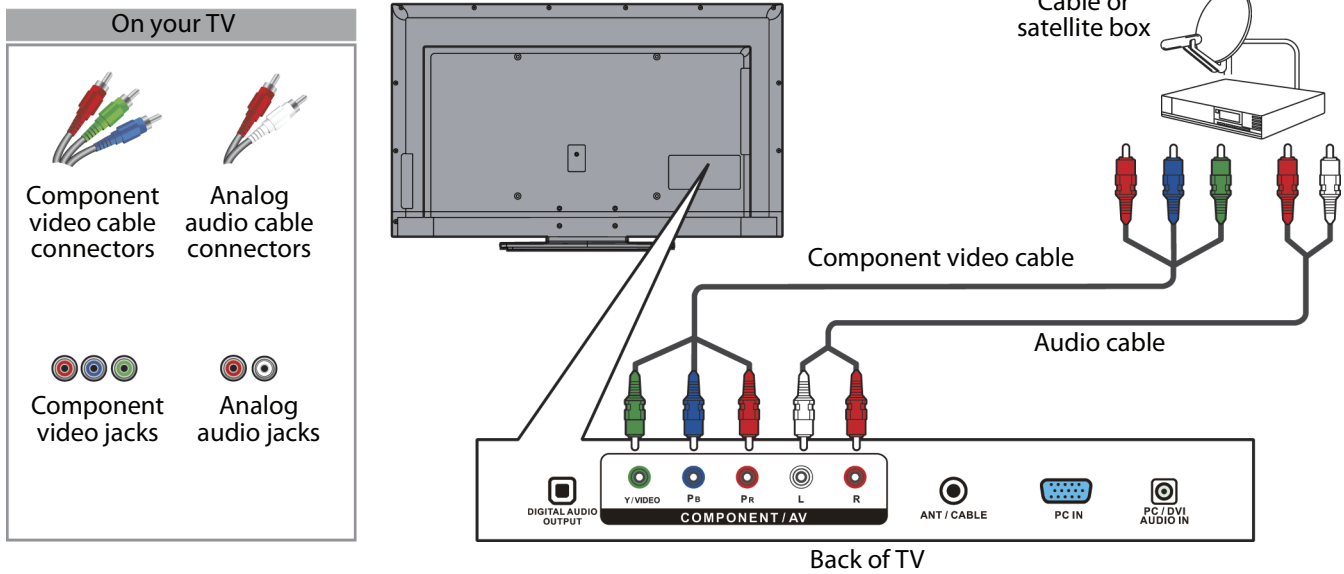

### To connect a cable or satellite box using component video:

- 1 Make sure that your TV's power cord is unplugged and all connected equipment is turned off.
- 2 Connect the incoming cable from the cable wall jack to the cable-in jack on the cable or satellite box.
- 3 Connect a component video cable (not provided) to the **COMPONENT/AV Y/VIDEO, PB, and PR** video jacks on the back of your TV and the component video out jacks on the cable or satellite box.
- 4 Connect an audio cable (not provided) to the **L** and **R** audio jacks on the back of your TV and to the audio out jacks on the cable or satellite TV box.

**Notes**

- The **COMPONENT/AV Y/VIDEO, PB, and PR** video jacks (used to connect a component video device) share the **L** and **R** audio jacks with the **COMPONENT/AV Y/VIDEO** jack (used to connect a composite video device).
- When you connect the audio using the **L** and **R** audio jacks, the audio output is analog.

- 5 Plug your TV's power cord into a power outlet, turn on your TV, then turn on the cable or satellite box.
- 6 Press **INPUT** to open the *INPUT SOURCE* list.
- 7 Press **▲** or **▼** to select **Component**, then press **ENTER**.

**Using composite video (good)**

**Notes**

- Cables are often color-coded to match color-coded jacks.
- The yellow video connector on the AV cable connects to the green **COMPONENT/AV Y/VIDEO** jack.

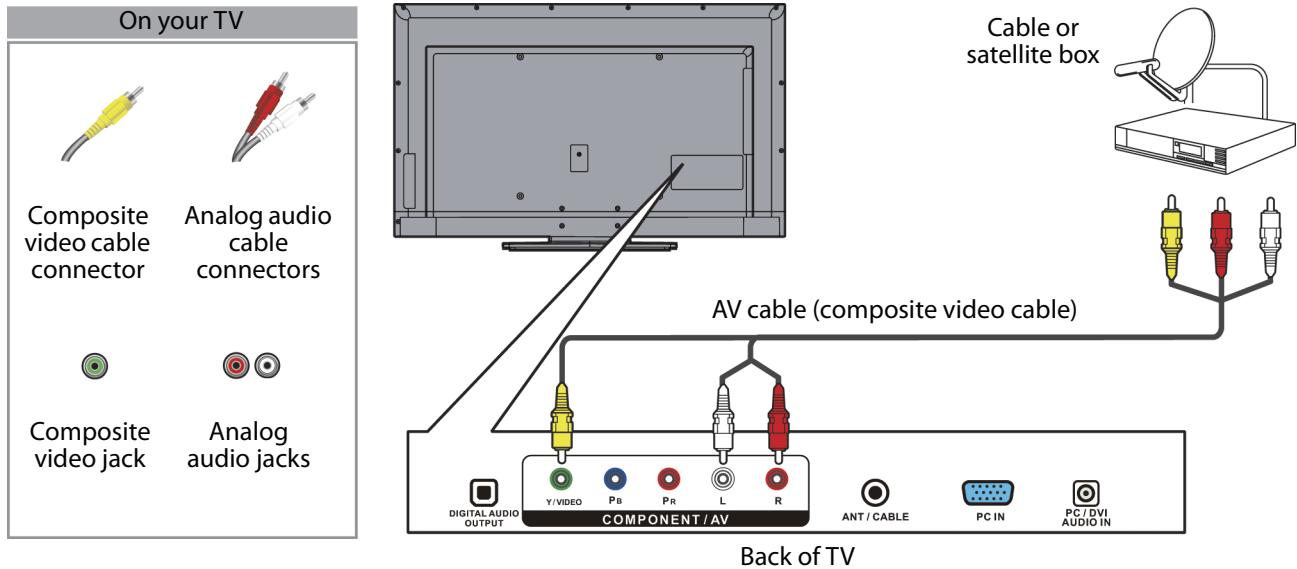

**To connect a cable or satellite box using composite video:**

- 1 Make sure that your TV's power cord is unplugged and all connected equipment is turned off.
- 2 Connect the incoming cable from the cable wall jack to the cable-in jack on the cable or satellite box.
- 3 Connect an AV cable (not provided) to the **COMPONENT/AV Y/VIDEO** jack and **L** and **R** audio jacks on the back of your TV and to the composite video and audio out jacks on the cable or satellite box.

**Notes**

- The **COMPONENT/AV Y/VIDEO**, **Pb**, and **Pr** video jacks (used to connect a component video device) share the **L** and **R** audio jacks with the **COMPONENT/AV Y/VIDEO** jack (used to connect a composite video device).
- When you connect the audio using the **L** and **R** audio jacks, the audio output is analog.

- 4 Plug your TV's power cord into a power outlet, turn on your TV, then turn on the cable or satellite box.
- 5 Press **INPUT** to open the *INPUT SOURCE* list.
- 6 Press **▲** or **▼** to select **AV**, then press **ENTER**.

## Using coaxial (good)

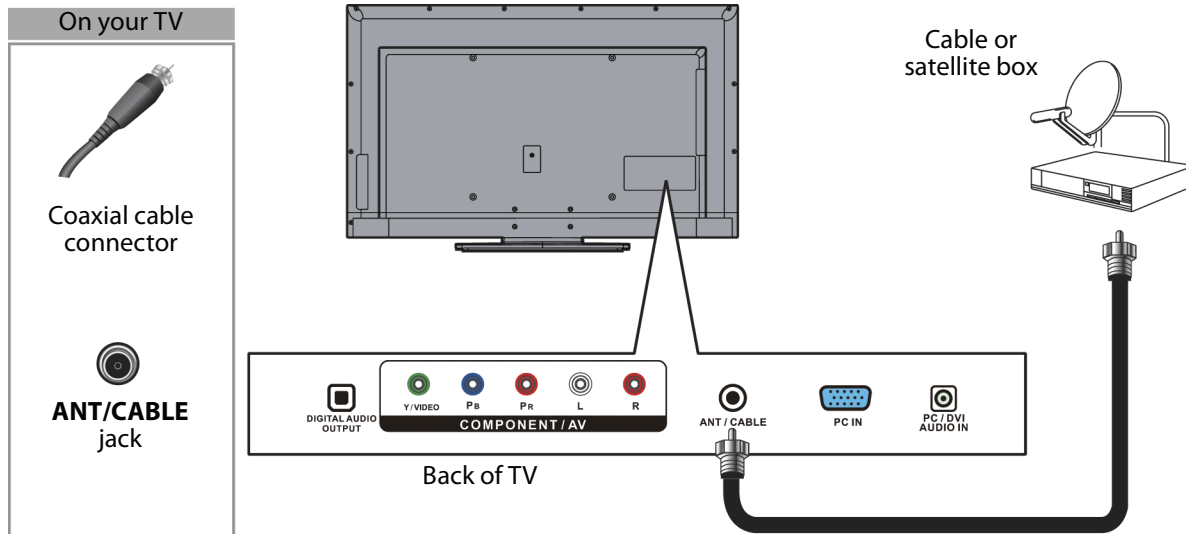

### To connect a cable or satellite box using coaxial:

- 1 Make sure that your TV's power cord is unplugged and all connected equipment is turned off.
- 2 Connect the incoming cable from the cable wall jack to the cable-in jack on the cable or satellite box.
- 3 Connect a coaxial cable (not provided) to the **ANT/CABLE** jack on the back of your TV and to the coaxial out jack on the cable or satellite box.
- 4 Plug your TV's power cord into a power outlet, turn on your TV, then turn on the cable or satellite box.
- 5 Press **INPUT** to open the *INPUT SOURCE* list.
- 6 Press **▲** or **▼** to highlight **TV**, then press **ENTER**.
- 7 If you cannot tune to channels you know exist, scan for channels. See "[Automatically scanning for channels](#)" on page 47.

#### Notes

- Use a coaxial cable to eliminate interference and noise from radio waves.
- Do not bundle the coaxial cable with the power cord or other cables.

## Connecting an antenna or cable TV (no box)

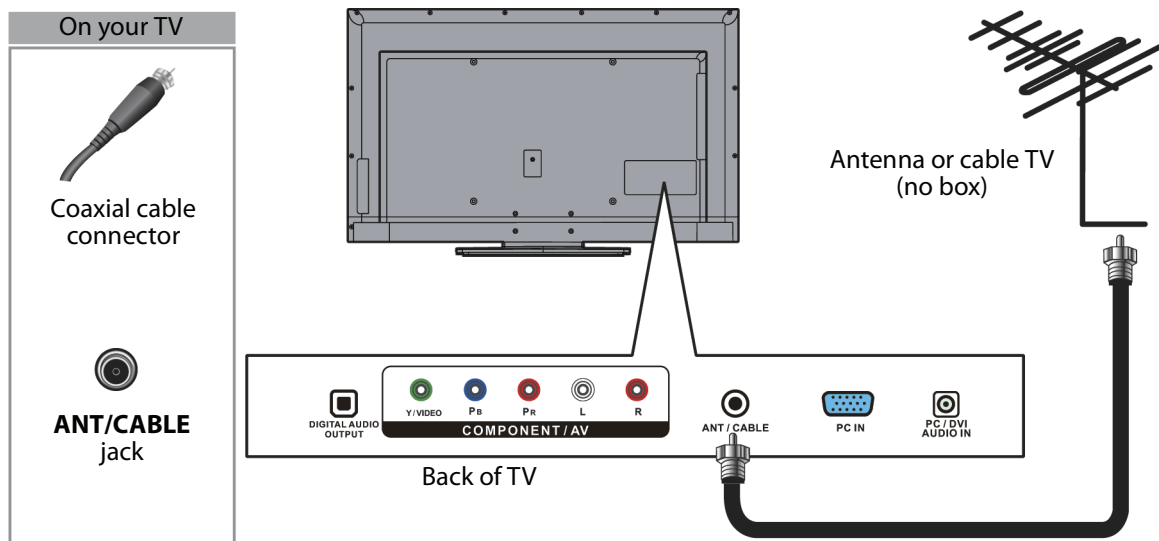

### To connect an antenna or cable TV (no box):

- 1 Make sure that your TV's power cord is unplugged and all connected equipment is turned off.
- 2 Connect a coaxial cable (not provided) to the **ANT/CABLE** jack on the back of your TV and to the antenna or cable TV wall jack.
- 3 Plug your TV's power cord into a power outlet, then turn on your TV.
- 4 Press **INPUT** to open the *INPUT SOURCE* list.
- 5 Press **▲** or **▼** to highlight **TV**, then press **ENTER**.
- 6 If you cannot tune to channels you know exist, scan for channels. See "[Automatically scanning for channels](#)" on page 47.

### Notes

- Use a coaxial cable to eliminate interference and noise from radio waves.
- Do not bundle the coaxial cable with the power cord or other cables.
- If the antenna is not installed correctly, contact qualified service personnel to correct the problem.
- If the signal level for a channel is weak, the picture may be distorted. Adjust the antenna or use a highly directional outdoor or set-top antenna with a built-in amplifier.
- If the picture quality is good on some channels and poor on others, the problem may be caused by a poor or weak signal from the broadcaster or cable TV provider.
- If you connect to cable or satellite TV without a set-top box and experience poor picture quality, you may need to install a set-top box to improve signal reception and picture quality. Contact your cable or satellite TV provider about upgrading to a set-top box.
- Many high-definition (HD) channels upscale standard-definition (SD) content. The picture displayed on your TV is still displayed as SD, thus the picture quality will not be as clear or crisp as it would be if the content was originally recorded in HD.



# Connecting a DVD or Blu-ray player

Many DVD or Blu-ray players have more than one connection type. To get the best video, you should use the best connection type available. For more information, see "What connection should I use?" on page 13.

## Using HDMI (best)

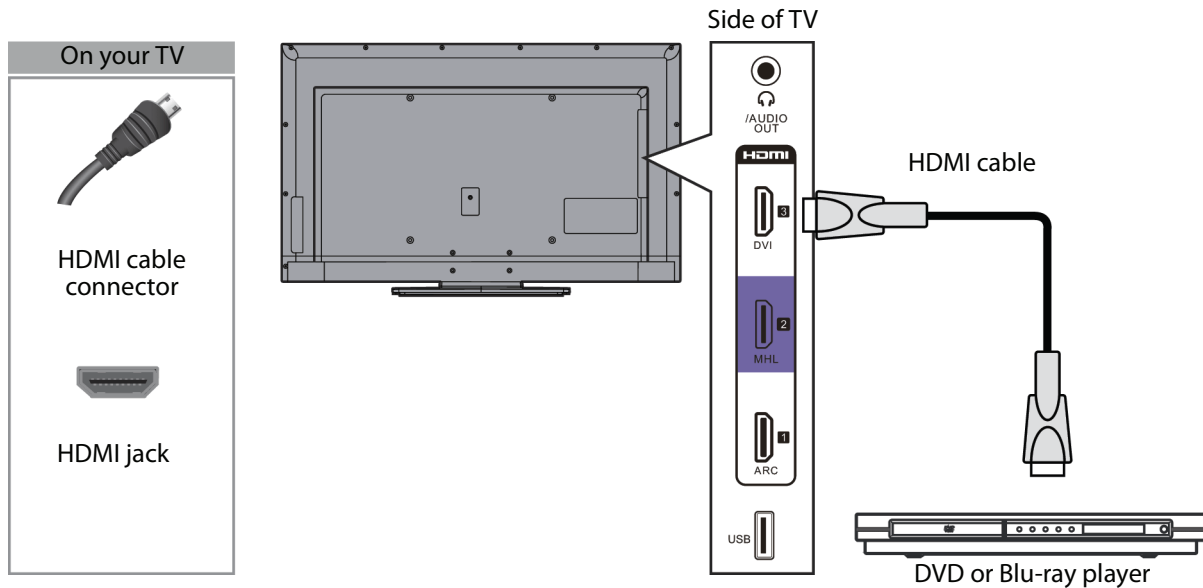

### To connect a DVD or Blu-ray player using HDMI:

- 1 Make sure that your TV's power cord is unplugged and the DVD or Blu-ray player is turned off.
- 2 Connect an HDMI cable (not provided) to one of the **HDMI** jacks on the side of your TV and to the **HDMI OUT** jack on the DVD or Blu-ray player.
- 3 Plug your TV's power cord into a power outlet, then turn on your TV.
- 4 Turn on the DVD or Blu-ray player, then set it to the correct output mode. For more information, see the documentation that came with the player.
- 5 Press **INPUT** to open the *INPUT SOURCE* list.
- 6 Press **▲** or **▼** to highlight **HDMI 1**, **HDMI 2**, or **HDMI 3**, then press **ENTER**.

#### Note

An HDMI cable carries both audio and video. You do not need to use any audio cables.

**Using DVI (same as HDMI but requires an audio connection)**

**Note**

You must use the **HDMI 3/DVI** jack to connect a DVD or Blu-ray player using DVI. If you use another HDMI jack, you will not hear sound from the TV speakers.

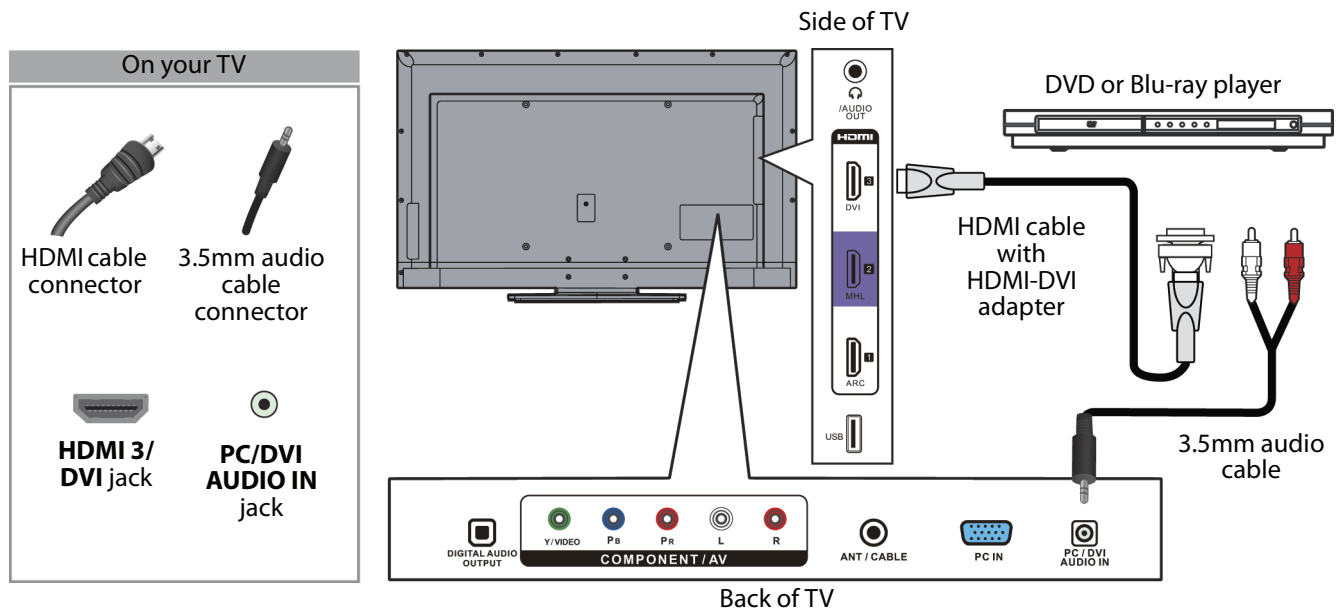

**To connect a DVD or Blu-ray player using DVI:**

- 1 Make sure that your TV's power cord is unplugged and the DVD or Blu-ray player is turned off.
- 2 Connect an HDMI-DVI adapter (not provided) to one end of an HDMI cable (not provided), then connect the adapter to the **DVI OUT** jack on the DVD or Blu-ray player.
- 3 Connect the other end of the cable to the **HDMI 3/DVI** jack on the side of your TV.
- 4 Connect a 3.5mm audio cable (not provided) to the **PC/DVI AUDIO IN** jack on the back of your TV and to the **AUDIO OUT** jacks on the DVD or Blu-ray player.

**Note**

When you connect the audio using the **PC/DVI AUDIO IN** jack, the audio output is analog.

- 5 Plug your TV's power cord into a power outlet, then turn on your TV.
- 6 Turn on the DVD or Blu-ray player, then set it to the correct output mode. For more information, see the documentation that came with the player.
- 7 Press **INPUT** to open the *INPUT SOURCE* list.
- 8 Press **▲** or **▼** to select **HDMI 3**, then press **ENTER**.

## Using component video (better)

### Note

Cables are often color-coded to match color-coded jacks.

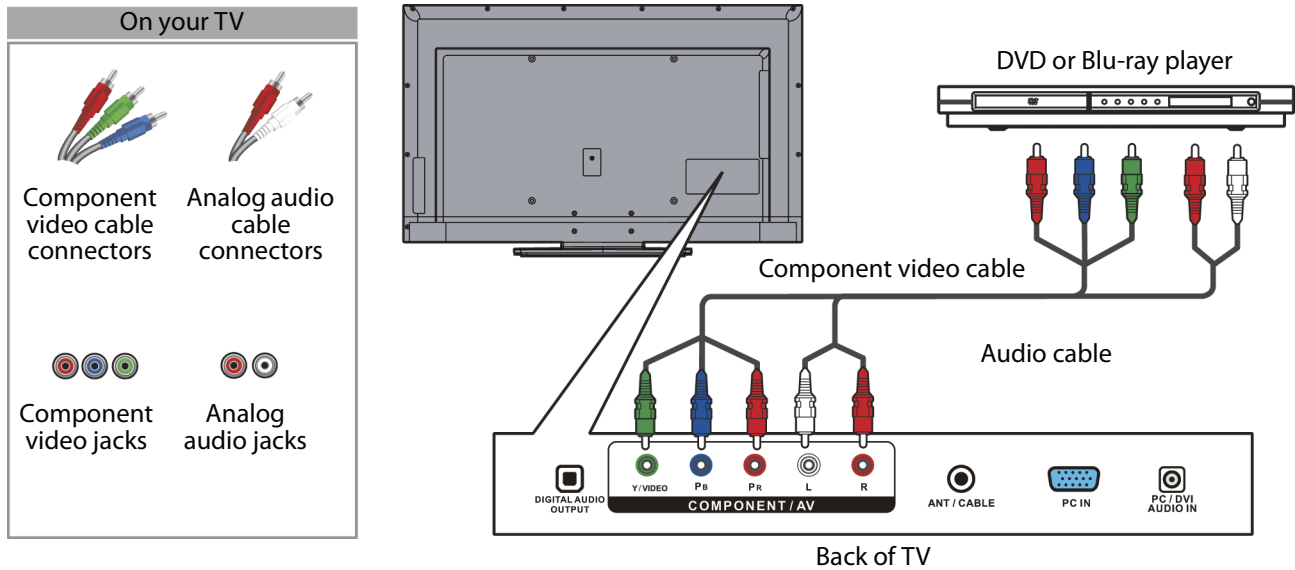

### To connect a DVD or Blu-ray player using component video:

- 1 Make sure that your TV's power cord is unplugged and the DVD or Blu-ray player is turned off.
- 2 Connect a component video cable (not provided) to the **COMPONENT/AV Y/VIDEO, PB, and PR** jacks on the back of your TV and to the **COMPONENT OUT** jacks on the DVD or Blu-ray player.
- 3 Connect an audio cable (not provided) to the **COMPONENT/AV L and R** audio jacks on the back of your TV and to the **L and R AUDIO OUT** jacks on the DVD or Blu-ray player.

### Notes

- The **COMPONENT/AV Y/VIDEO, PB, and PR** video jacks (used to connect a component video device) share the **L and R** audio jacks with the **COMPONENT/AV Y/VIDEO** jack (used to connect a composite video device).
- When you connect the audio using the **L and R** audio jacks, the audio output is analog.

- 4 Plug your TV's power cord into a power outlet, then turn on your TV.
- 5 Turn on the DVD or Blu-ray player, then set it to the correct output mode. For more information, see the documentation that came with the player.
- 6 Press **INPUT** to open the **INPUT SOURCE** list.
- 7 Press **▲** or **▼** to select **Component**, then press **ENTER**.

**Using composite video (good)**

**Notes**

- Cables are often color-coded to match color-coded jacks.
- The yellow video connector on the AV cable connects to the green **COMPONENT/AV Y/VIDEO** jack.

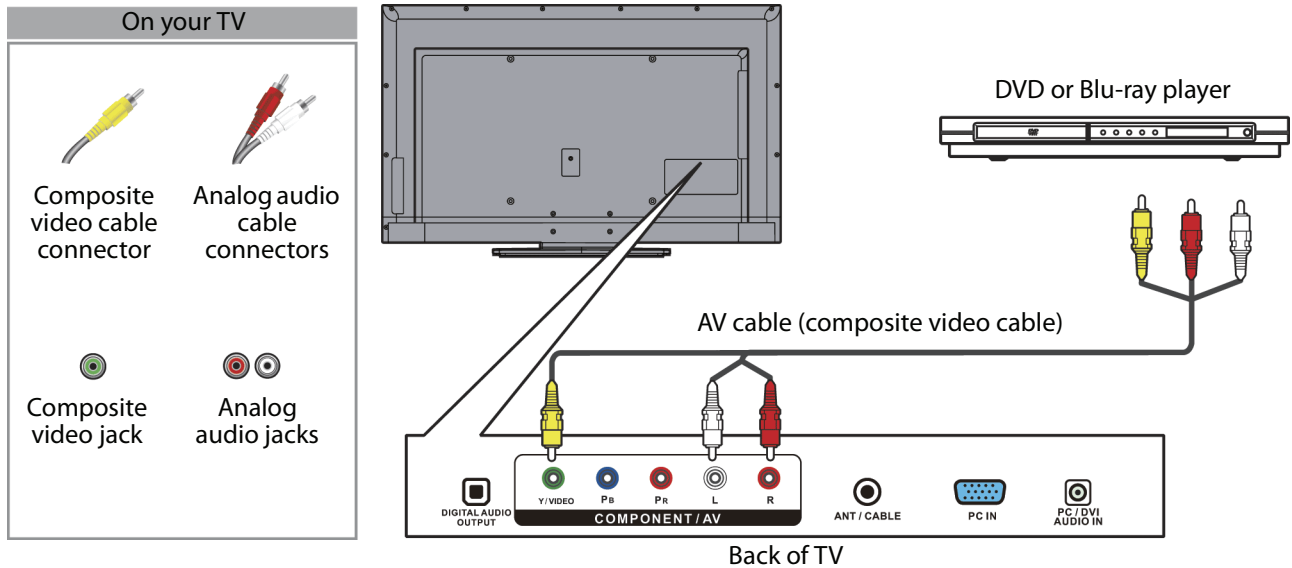

**To connect a DVD or Blu-ray player using composite video:**

- 1 Make sure that your TV's power cord is unplugged and the DVD or Blu-ray player is turned off.
- 2 Connect an AV cable (not provided) to the **COMPONENT/AV Y/VIDEO** jack and **L** and **R** audio jacks on the back of your TV and to the **AV OUT** jacks on the DVD or Blu-ray player.

**Notes**

- The **COMPONENT/AV Y/VIDEO**, **Pb**, and **Pr** video jacks (used to connect a component video device) share the **L** and **R** audio jacks with the **COMPONENT/AV Y/VIDEO** jack (used to connect a composite video device).
- When you connect the audio using the **L** and **R** audio jacks, the audio output is analog.

- 3 Plug your TV's power cord into a power outlet, then turn on your TV.
- 4 Turn on the DVD or Blu-ray player, then set it to the correct output mode. For more information, see the documentation that came with the player.
- 5 Press **INPUT** to open the **INPUT SOURCE** list.
- 6 Press **▲** or **▼** to select **AV**, then press **ENTER**.

## Connecting an MHL-enabled device

You can connect an MHL-enabled device, such as a cell phone or Roku Streaming Stick™, and view your device's screen on your TV.

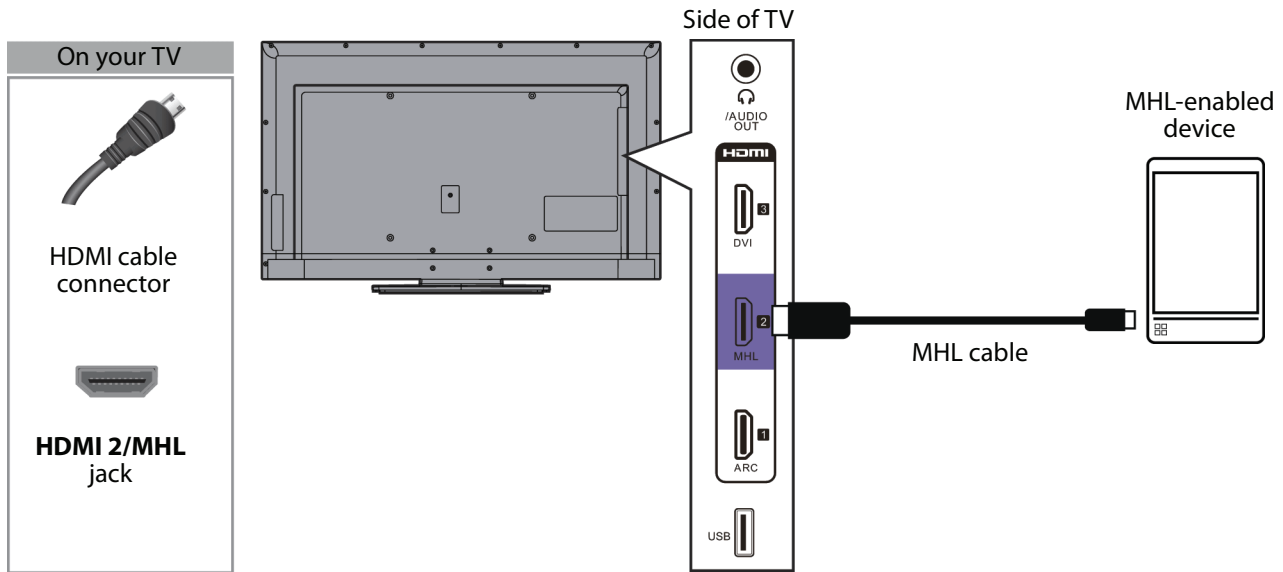

### To connect an MHL-enabled device:

- 1 Connect the small connector on an MHL cable (not provided) to the micro USB port on the MHL-enabled device.
- 2 Connect the other end of the cable to the **HDMI 2/MHL** jack on the side of your TV.
- 3 Turn on the MHL-enabled device.
- 4 If your TV is turned on, press **ENTER** when a message appears. Your MHL-enabled device's menu opens.

OR

If your TV is turned off, turn on your TV. Press **HOME**. Your MHL-enabled device's menu opens.

### Notes

You can also switch to MHL mode by:

- Pressing **INPUT** and selecting **HDMI 2 (MHL/ACC)** or **HDMI 2 (Roku)**
- Pressing **MENU** and selecting **MHL/ACC** or **Streaming**

For instructions on using your MHL-enabled device, see ["Using an MHL-enabled device or Roku Streaming Stick"](#) on page 64.

# Connecting a game console

## Using HDMI (best)

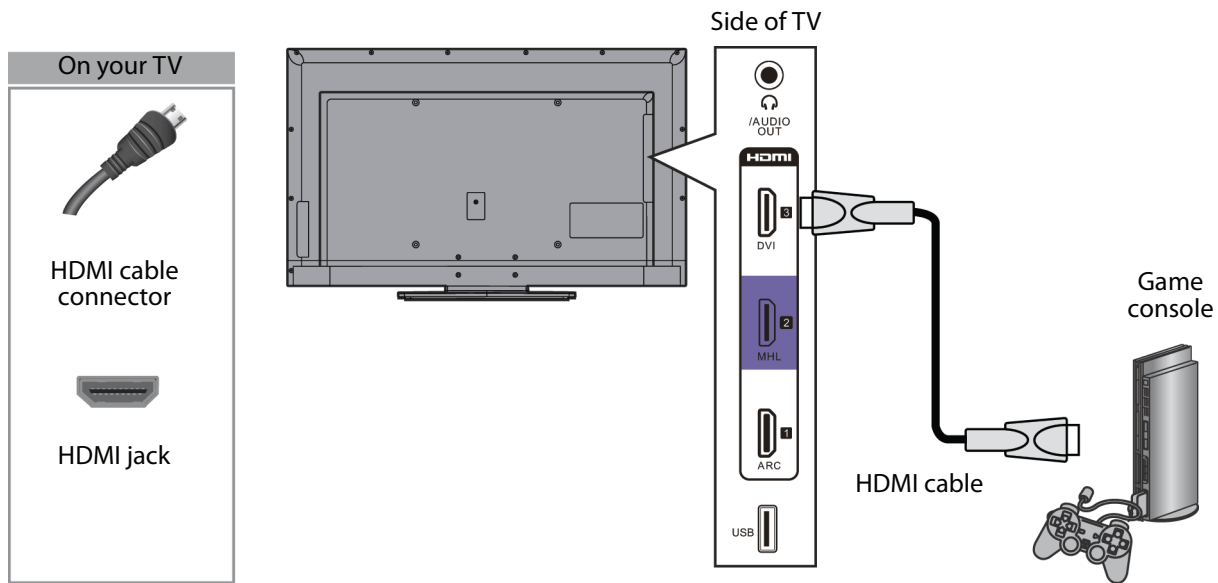

### To connect a game console using HDMI:

- 1 Make sure that your TV's power cord is unplugged and the game console is turned off.
- 2 Connect an HDMI cable (not provided) to one of the **HDMI** jacks on the side of your TV and to the **HDMI OUT** jack on the game console.
- 3 Plug your TV's power cord into a power outlet, then turn on your TV.
- 4 Turn on the game console, then set it to the correct output mode. For more information, see the documentation that came with the console.
- 5 Press **INPUT** to open the *INPUT SOURCE* list.
- 6 Press **▲** or **▼** to highlight **HDMI 1**, **HDMI 2**, or **HDMI 3**, then press **ENTER**.

#### Note

An HDMI cable carries both audio and video. You do not need to use any audio cables.

## Using component video (better)

### Note

Cables are often color-coded to match color-coded jacks.

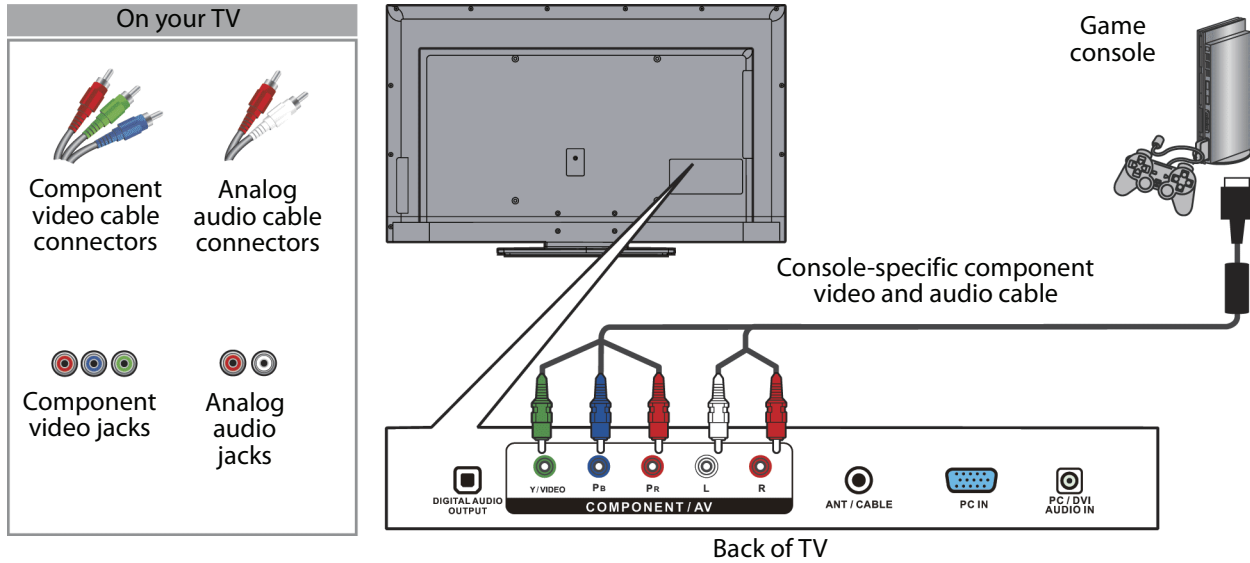

### To connect a game console using component video:

- 1 Make sure that your TV's power cord is unplugged and the game console is turned off.
- 2 Connect the video and audio connectors on the component video cable (not provided) to the **COMPONENT/AV Y/VIDEO, Pb, and Pr** video jacks and **COMPONENT/AV L and R** audio jacks on the back of your TV and to the component jack(s) on the game console.

### Note

- Your game console may require a special component video cable. See the documentation that came with your game console or check the manufacturer's website.
- The **COMPONENT/AV Y/VIDEO, Pb, and Pr** video jacks (used to connect a component video device) share the **L and R** audio jacks with the **COMPONENT/AV Y/VIDEO** jack (used to connect a composite video device).
- When you connect the audio using the **L and R** audio jacks, the audio output is analog.

- 3 Plug your TV's power cord into a power outlet, then turn on your TV.
- 4 Turn on the game console, then set it to the correct output mode. For more information, see the documentation that came with the console.
- 5 Press **INPUT** to open the *INPUT SOURCE* list.
- 6 Press **▲** or **▼** to select **Component**, then press **ENTER**.

**Using composite video (good)**

**Notes**

- Cables are often color-coded to match color-coded jacks.
- The yellow video connector on the AV cable connects to the green **COMPONENT/AV Y/VIDEO** jack.

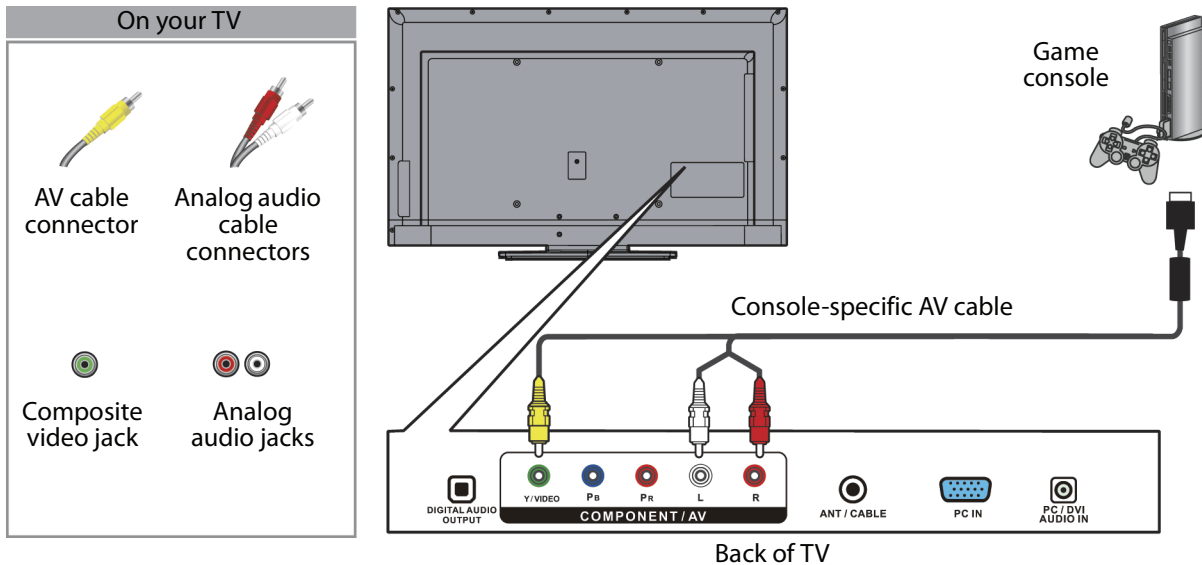

**To connect a game console using composite video:**

- 1 Make sure that your TV's power cord is unplugged and the game console is turned off.
- 2 Connect the video and audio connectors on the game console's AV cable (not provided) to the **COMPONENT/AV Y/VIDEO** jack and **L** and **R** audio jacks on the back of your TV and to the composite jack(s) on the game console.

**Note**

- Most game consoles come with a special AV (composite video) cable. See the documentation that came with your game console or check the manufacturer's Web site.
- The **COMPONENT/AV Y/VIDEO**, **Pb**, and **Pr** video jacks (used to connect a component video device) share the **L** and **R** audio jacks with the **COMPONENT/AV Y/VIDEO** jack (used to connect a composite video device).
- When you connect the audio using the **L** and **R** audio jacks, the audio output is analog.

- 3 Plug your TV's power cord into a power outlet, then turn on your TV.
- 4 Turn on the game console, then set it to the correct output mode. For more information, see the documentation that came with the console.
- 5 Press **INPUT** to open the *INPUT SOURCE* list.
- 6 Press **▲** or **▼** to select **AV**, then press **ENTER**.



# Connecting a computer

## Using VGA (most common)

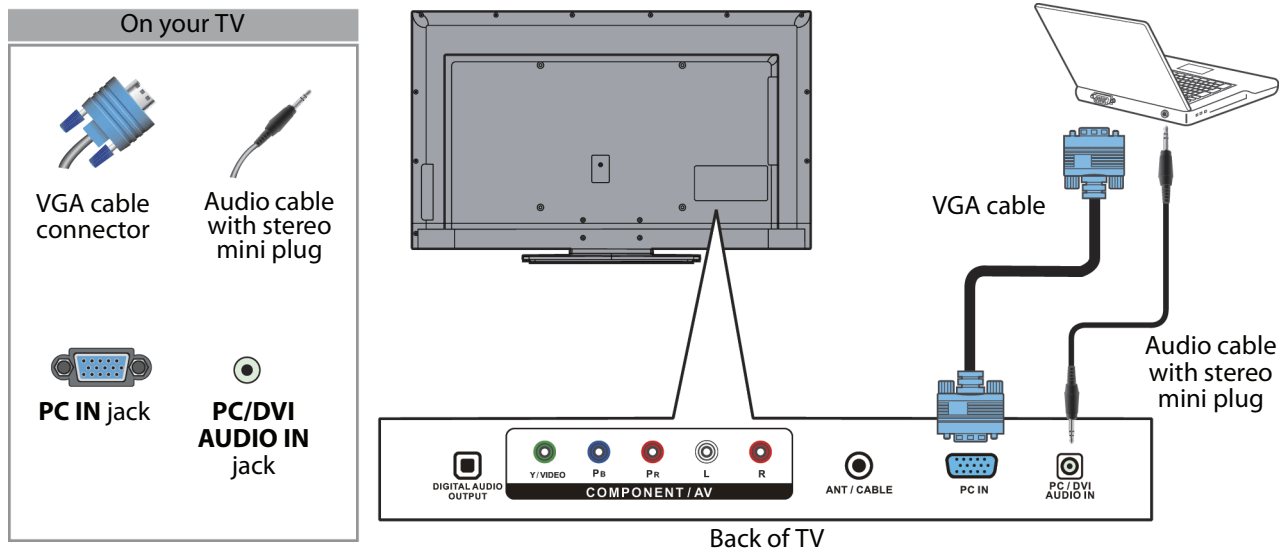

### To connect a computer using VGA:

- 1 Make sure that your TV's power cord is unplugged and the computer is turned off.
- 2 Connect a VGA cable (not provided) to the **PC IN** jack on the back of your TV and to the **VGA** jack on the computer.
- 3 Connect an audio cable with a stereo mini plug (not provided) to the **PC/DVI AUDIO IN** jack on the back of your TV and to the **AUDIO OUT** (headphone) jack on the computer.
- 4 Plug your TV's power cord into a power outlet, then turn on your TV and the computer.
- 5 Press **INPUT** to open the **INPUT SOURCE** list.
- 6 Press **▲** or **▼** to select **PC**, then press **ENTER**.
- 7 Adjust the display properties on the computer, if necessary.

**Using HDMI (best)**

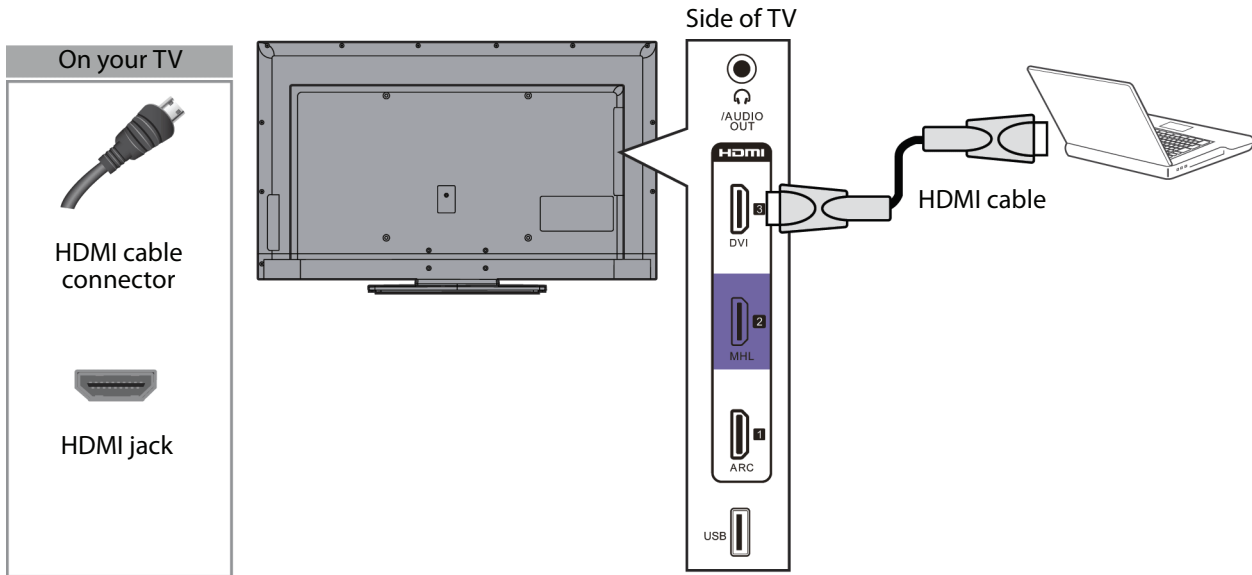

**To connect a computer using HDMI:**

- 1 Make sure that your TV's power cord is unplugged and the computer is turned off.
- 2 Connect an HDMI cable (not provided) to one of the **HDMI** jacks on the side of your TV and to the **HDMI OUT** jack on the computer.
- 3 Plug your TV's power cord into a power outlet, then turn on your TV and the computer.
- 4 Press **INPUT** to open the *INPUT SOURCE* list.
- 5 Press **▲** or **▼** to highlight **HDMI 1**, **HDMI 2**, or **HDMI 3**, then press **ENTER**.
- 6 Adjust the display properties on the computer, if necessary.

## Using DVI (same as HDMI but requires an audio connection)

### Note

You must use the **HDMI 3/DVI** jack to connect a computer using DVI. If you use another HDMI jack, you will not hear sound from the TV speakers.

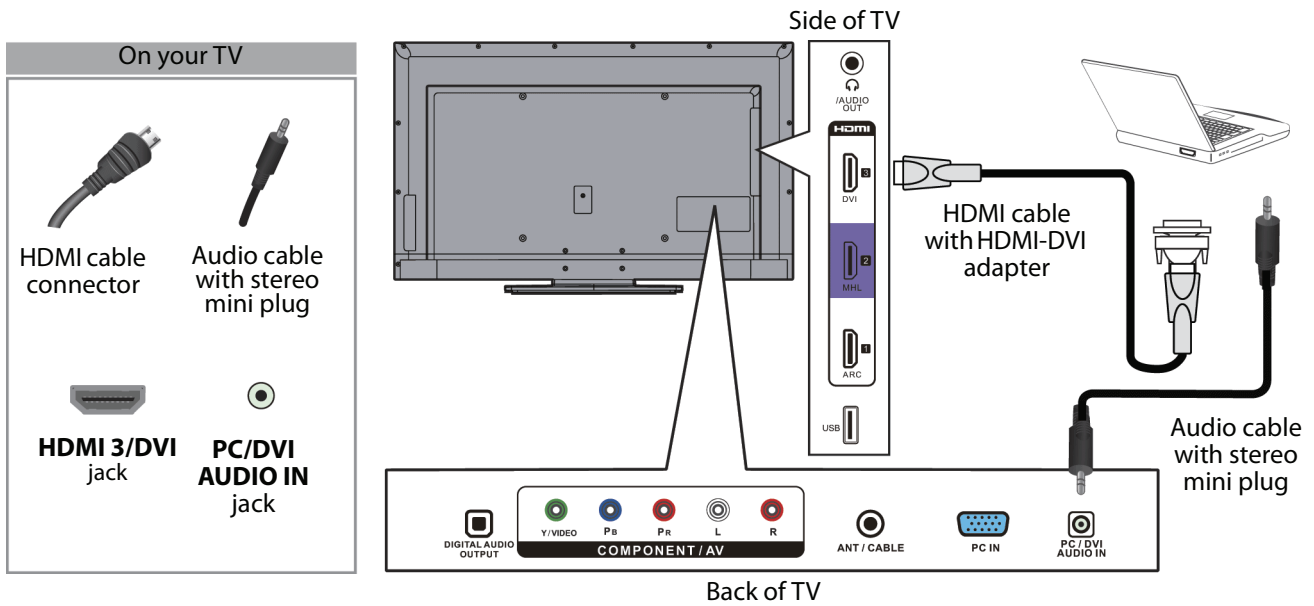

### To connect a computer using DVI:

- 1 Make sure that your TV's power cord is unplugged and the computer is turned off.
- 2 Connect an HDMI-DVI adapter (not provided) to one end of an HDMI cable (not provided), then connect the adapter to the **DVI OUT** jack on the computer.
- 3 Connect the other end of the cable to the **HDMI 3/DVI** jack on the side of your TV.
- 4 Connect an audio cable with a stereo mini plug (not provided) to the **PC/DVI AUDIO IN** jack on the back of your TV and to the **AUDIO OUT** (headphone) jack on the computer.

### Note

When you connect the audio using the **PC/DVI AUDIO IN** jack, the audio output is analog.

- 5 Plug your TV's power cord into a power outlet, then turn on your TV and the computer.
- 6 Press **INPUT** to open the **INPUT SOURCE** list.
- 7 Press **▲** or **▼** to select **HDMI 3**, then press **ENTER**.
- 8 Adjust the display properties on the computer, if necessary.

## Connecting a USB flash drive

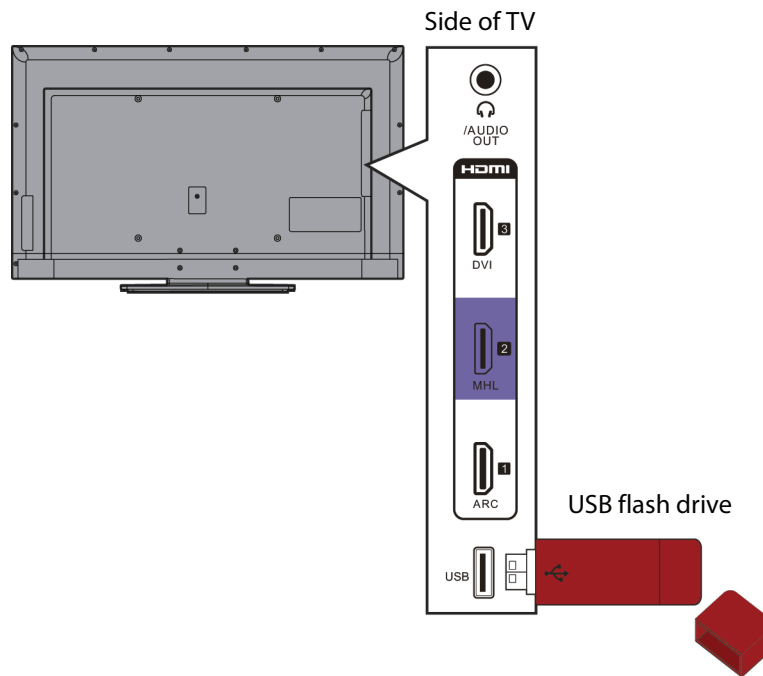

### To connect a USB flash drive:

- 1 Plug a USB flash drive into the **USB** port on the side of your TV.

#### Caution

Do not remove the USB flash drive or turn off the TV while using the USB flash drive. You may lose data or damage the USB flash drive.

- 2 If your TV is turned on when you connect the USB flash drive, press **▲** or **▼** to select **Yes** in the message that appears, then press **ENTER**. The *PHOTOS* menu opens.

OR

If you switch to a different video input source after you plug in the USB flash drive and want to switch back to the drive, press **INPUT** to open the *INPUT SOURCE* list, press **▲** or **▼** to select **USB(Photos)**, then press **ENTER**. The *PHOTOS* menu opens.

#### Note

The **PHOTOS** viewer only supports JPEG format images (with ".jpg" file extensions) and not all JPEG files are compatible with your TV. For more information, see "[Using a USB flash drive](#)" on page 66.

# Connecting headphones

When you connect headphones, the TV speakers muted.

## Warning

Loud noise can damage your hearing. When using headphones, use the lowest volume setting on your headphones that still lets you hear the sound.

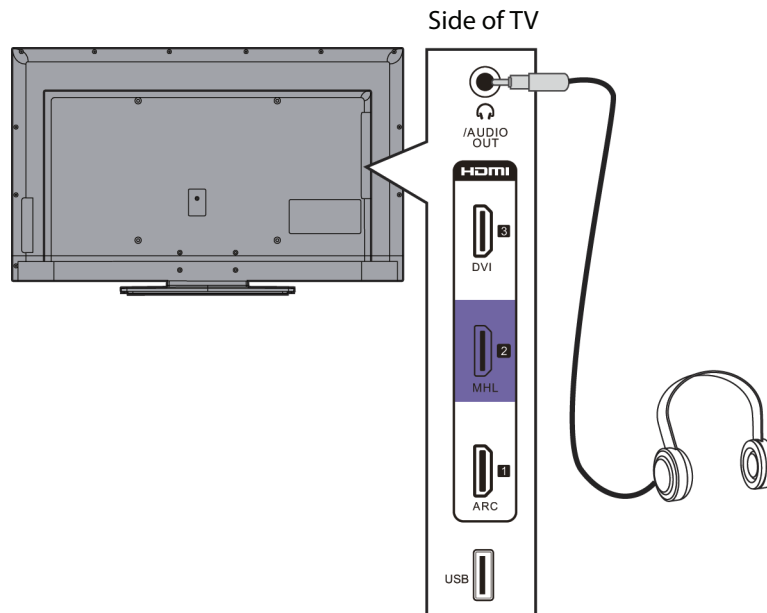

## To connect headphones:

- 1 Connect the headphones to the /AUDIO OUT jack on the side of your TV.
- 2 In the screen that opens, press or to highlight **Headphone**, then press **ENTER**. For more information, see ["Selecting the audio out mode"](#) on page 46.

## Notes

- If you connect headphones when your TV is turned off, then you turn on your TV, the TV speakers are muted and the audio plays through the headphones.
- You can also connect an amplifier, home theater system, or sound bar to the /AUDIO OUT jack. If you want to connect an amplifier, home theater system, or sound bar, you need to disconnect the headphones.

# Connecting a basic home theater system

## Using digital audio

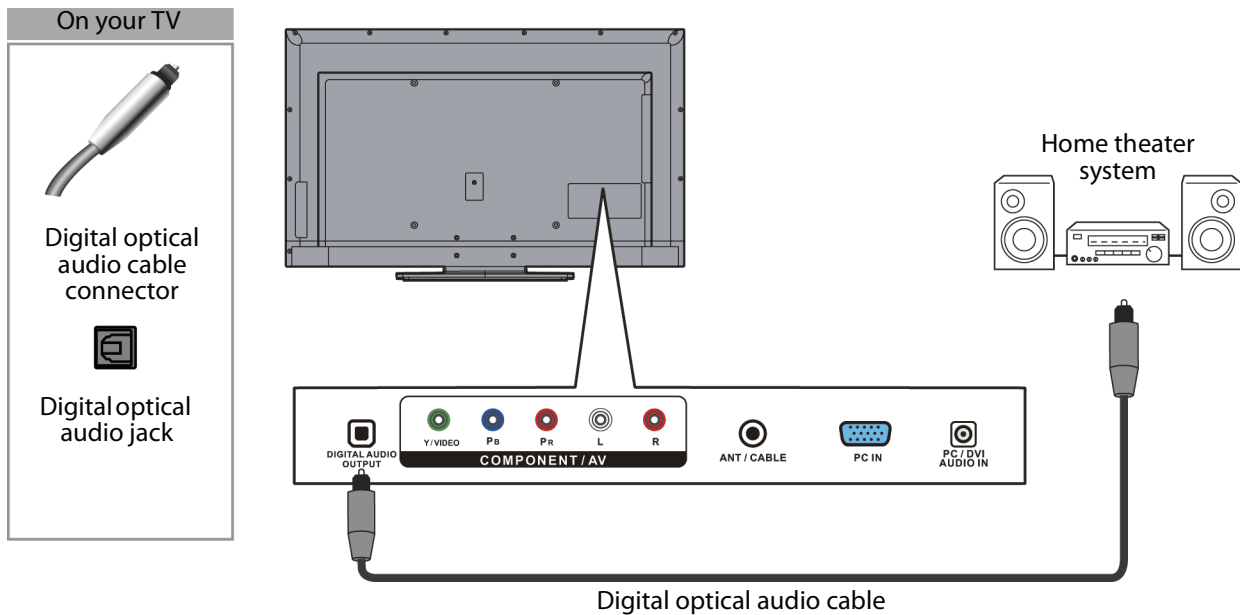

### To connect a basic home theater system or sound bar using digital audio:

- 1 Make sure that your TV's power cord is unplugged and the home theater system or sound bar is turned off.
- 2 Connect a digital optical audio cable (not provided) to the **DIGITAL AUDIO OUTPUT** jack on the back of your TV and to the optical **AUDIO IN** jack on the digital home theater system or sound bar.
- 3 Plug your TV's power cord into a power outlet, then turn on your TV.
- 4 Turn on the home theater system or sound bar, then set it to the correct source. For more information, see the documentation that came with the home theater system or sound bar.
- 5 On your TV, set the **Digital Audio Out** option on the **AUDIO** menu to **PCM**. See "[Adjusting sound settings](#)" on page 45.

## Using analog audio

When you connect a home theater system or sound bar to the /AUDIO OUT jack, the TV speakers are muted.

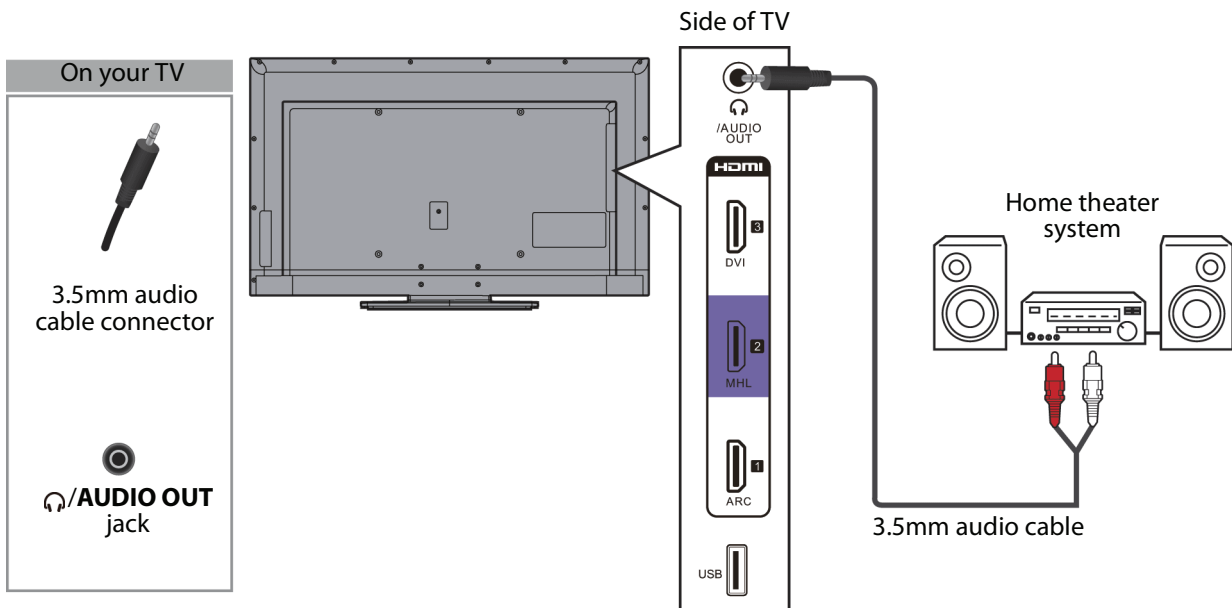

### To connect a home theater system or sound bar using analog audio:

- 1 Make sure that your TV's power cord is unplugged and the home theater system or sound bar is turned off.
- 2 Connect a 3.5mm audio cable (not provided) to the /AUDIO OUT jack on the side of your TV and to the **AUDIO IN** jacks on the analog home theater system or sound bar.
- 3 Plug your TV's power cord into a power outlet, then turn on your TV.
- 4 Turn on the home theater system or sound bar, then set it to the correct source. For more information, see the documentation that came with the home theater system or sound bar.

#### Notes

- For information about selecting the audio out mode for a home theater or sound bar, see the **Headphones/Audio Out** option in "[Adjusting sound settings](#)" on page 45.
- You can connect headphones to the /AUDIO OUT jack. If you want to use headphones, you need to disconnect the amplifier, home theater system, or sound bar.

## Connecting a home theater system with multiple devices

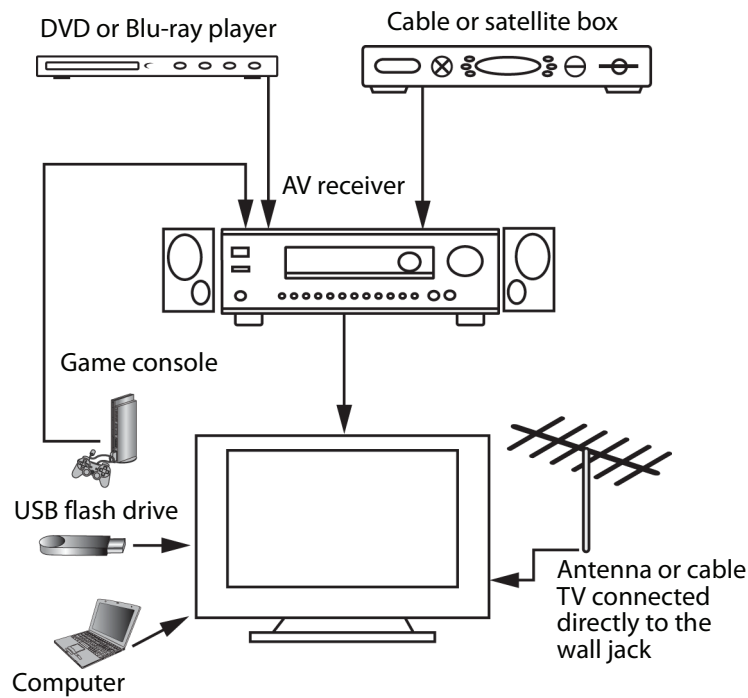

The connections you make depend on the video and audio jacks available on your devices. Refer to the documentation that came with your devices for connection information.

Just remember to use the best connection types available for the best picture and sound. For information about connection types, see [“What connection should I use?”](#) on page 13.



## Connecting power

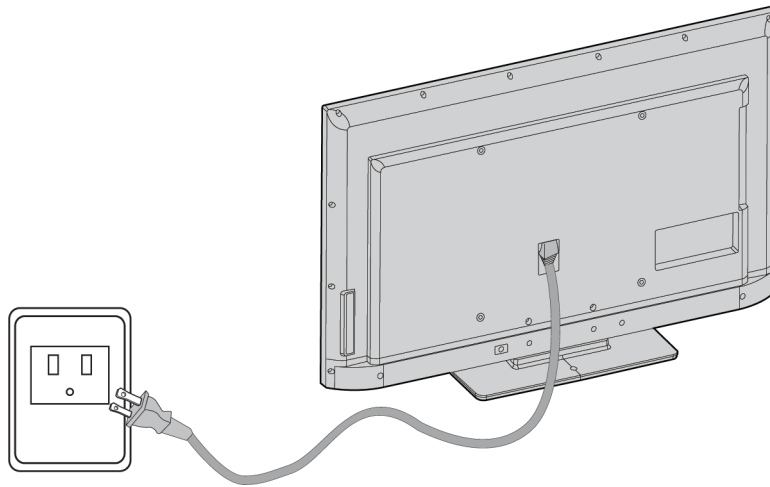

### To connect the power:

- 1 Connect the AC power cord to the AC IN connector on the back of your TV.
- 2 Connect the other end of the cord to a power outlet.

#### Caution

- Your TV should only be operated from the power source indicated on the label.
- Always unplug the AC power cord from the power outlet when you will not be using your TV for an extended period of time.

# Using the remote control

## Installing remote control batteries

### To install remote control batteries:

- 1 While pressing the release latch on the back of the remote control, lift the battery compartment cover off of the remote control.

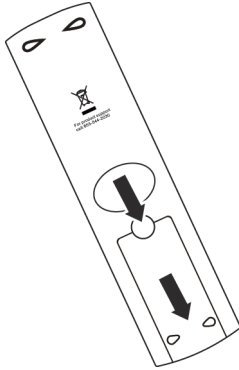

- 2 Insert two AAA batteries into the battery compartment. Make sure that you match the + and - symbols on the batteries with the + and - symbols in the battery compartment.

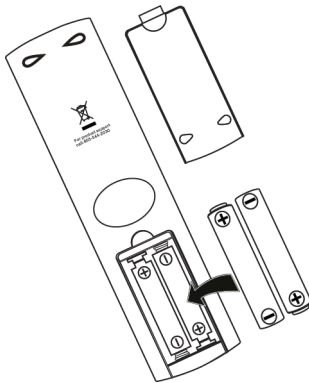

- 3 Replace the battery compartment cover.

### Cautions

- Batteries should not be exposed to excessive heat, such as sunshine, heat registers, or fire.
- Battery chemicals can cause a rash. If the batteries leak, clean the battery compartment with a cloth. If chemicals touch your skin, wash immediately.
- Make sure that batteries are disposed of correctly. Do not burn or incinerate.

### Notes

- Do not mix batteries of different types.
- Do not mix old and new batteries.
- Remove batteries when the charge is depleted.
- If the remote control is not going to be used for an extended period of time, remove the batteries.

## Aiming the remote control

### To aim the remote control:

- Point the remote control towards the remote sensor on the front of your TV. For the location of the remote sensor, see "Front" on page 9.

# Turning on your TV for the first time

The first time you turn on your TV, the *EZ SETUP* wizard opens. The wizard guides you through setting up basic settings including the menu language, time setting, picture mode, TV signal source, and channel list.

## To set up your TV:

- 1 Make sure that you have:
  - Installed the remote control batteries. (See page 37 for details.)
  - Connected an antenna, cable TV, or satellite TV. (See page 14 through 19 for details.)
  - Connected the power cord. (See page 36 for details.)
- 2 Press  $\odot$  (power) to turn on your TV. The *Please select your language* screen opens.

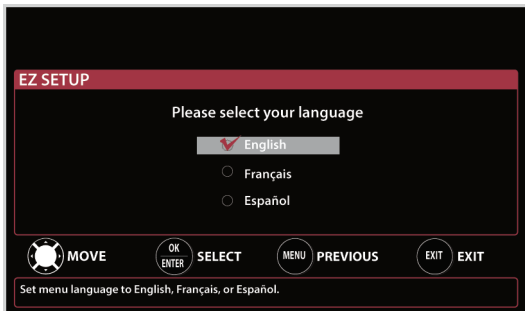

- 3 Press  $\blacktriangle$  or  $\blacktriangledown$  to highlight the language you want, then press **ENTER**. The time setting screen opens.

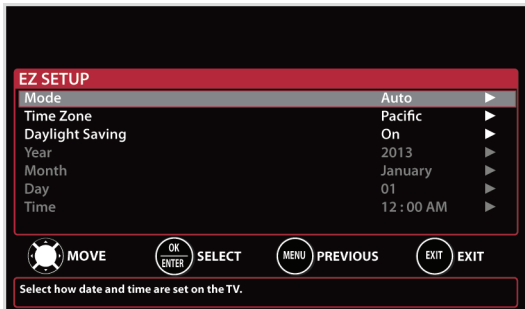

- 4 Press  $\blacktriangle$  or  $\blacktriangledown$  to highlight **Mode**, then press  $\blacktriangleright$  to access the setting.
- 5 Press  $\blacktriangle$  or  $\blacktriangledown$  to select **Manual** (to set the date and time manually) or **Auto** (to set the date and time automatically from a TV signal source based on the time zone you select), then press **ENTER, MENU, or  $\blacktriangleleft$** .

### Note

If you select **Auto**, the displayed time will be incorrect until your TV gets the correct time from a TV signal source.

- 6 Press  $\blacktriangle$  or  $\blacktriangledown$  to highlight **Time Zone**, then press  $\blacktriangleright$  to access the setting.
- 7 Press  $\blacktriangle$  or  $\blacktriangledown$  to select your time zone. You can select **Eastern, Central, Mountain, Pacific, Alaska, Hawaii, Atlantic, or Newfoundland**, then press **ENTER, MENU, or  $\blacktriangleleft$** .
- 8 Press  $\blacktriangle$  or  $\blacktriangledown$  to highlight **Daylight Saving**, then press  $\blacktriangleright$  to access the setting.
- 9 Press  $\blacktriangle$  or  $\blacktriangledown$  to select **On** (if your viewing area observes Daylight Saving Time) or **Off** (if your viewing area does not observe Daylight Saving Time), then press **ENTER, MENU, or  $\blacktriangleleft$** .
- 10 If you selected **Manual** for **Mode**:
  - Press  $\blacktriangle$  or  $\blacktriangledown$  to highlight **Year, Month, or Day**, then press  $\blacktriangleright$  to access the setting. Press  $\blacktriangle$  or  $\blacktriangledown$  to adjust the setting, then press **ENTER**.
  - Press  $\blacktriangle$  or  $\blacktriangledown$  to highlight **Time**, then press  $\blacktriangleright$  to access the setting. Press  $\blacktriangleleft$  or  $\blacktriangleright$  to highlight the hour, minute, or AM/PM field, then press  $\blacktriangle$  or  $\blacktriangledown$  to adjust the setting. When you are finished, press **ENTER**.
- 11 When you have finished setting the time, press **ENTER**. The *What is your viewing environment* screen opens.

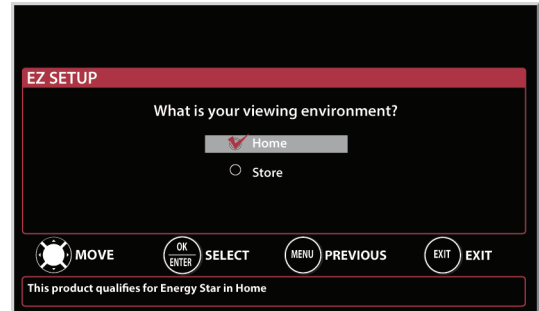

- 12 Press  $\blacktriangle$  or  $\blacktriangledown$  to highlight **Home** or **Store**, then press **ENTER**.

If you selected **Store** mode, a message asks if you are sure you want this mode. Select **Yes** to continue using **Store** mode or select **No** to change your selection, then press **ENTER**. **Store** mode is not an energy savings mode and displays a retail banner.

The *Please select your tuner mode* screen opens.

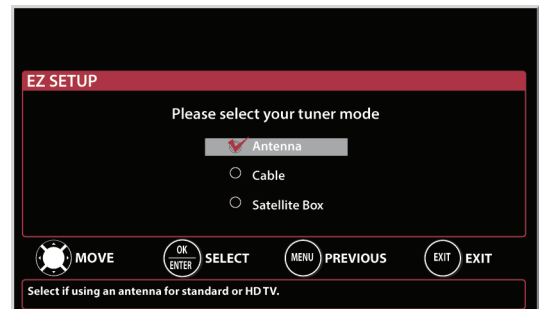

**13** Press **▲** or **▼** to highlight **Antenna, Cable,** or **Satellite Box,** then press **ENTER.**

**A** If you select **Antenna,** your TV scans for available channels. The scan may take several minutes.

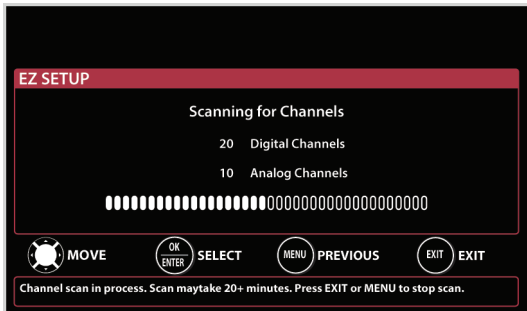

**Note**  
You can press **EXIT** to stop the auto channel search, but you will need to run the auto channel search again to create a channel list.

**B** If you select **Cable,** a message asks if you have a cable box:

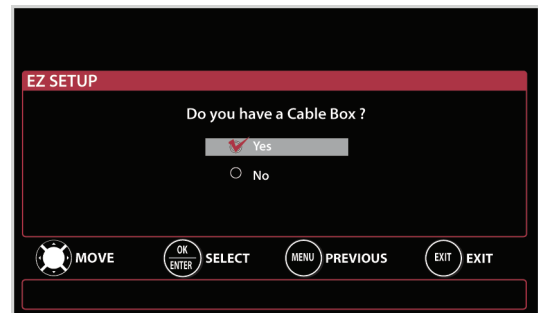

- Select **No**, then press **ENTER** if no cable box is connected. Your TV scans for available channels. The scan may take several minutes.
- Select **Yes**, then press **ENTER** if a cable box is connected. A message asks how you connected the cable box to your TV.

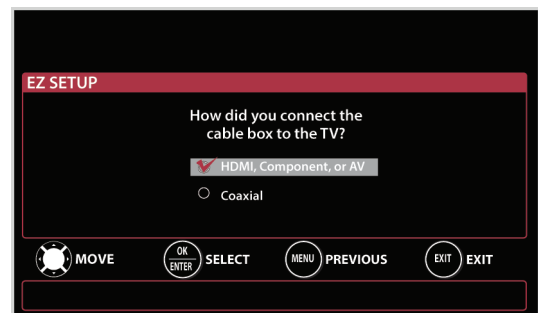

- Select **HDMI, Component, or AV**, then press **ENTER** if you connected a cable box to your TV using one of these cables. Read the message, then press **ENTER** to close the wizard.
- Select **Coaxial**, then press **ENTER** if you connected a cable box to your TV using a coaxial cable. Read the message, then press **ENTER** to start the channel scan (VHF channels only).

**Note**  
You can press **EXIT** to stop the auto channel search, but you will need to run the auto channel search again to create a channel list.

- C If you select **Satellite Box**, a message asks how you connected the satellite box to your TV:

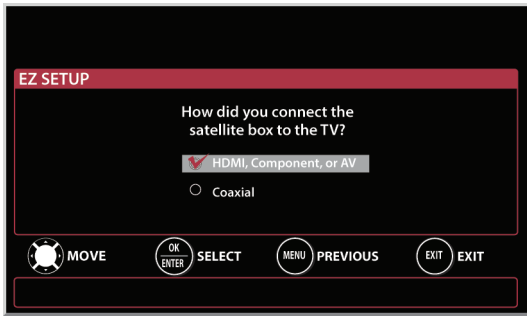

- Select **HDMI, Component, or AV**, then press **ENTER** if you connected a satellite box to your TV using one of these cables. Read the message, then press **ENTER** to close the wizard.
- Select **Coaxial**, then press **ENTER** if you connected a satellite box to your TV using a coaxial cable. Read the message, then press **ENTER** to start the channel scan (VHF channels only).

**Note**

You can press **EXIT** to stop the auto channel search, but you will need to run the auto channel search again to create a channel list.

- 14 To watch TV, press **INPUT**, press **▲** or **▼** to highlight the video input source for your TV in the **INPUT SOURCE** list, then press **ENTER**.
  - If your TV is connected to an antenna, cable TV (no box), or cable or satellite TV box using a coaxial cable, select **TV**.
  - If your TV is connected to a cable or satellite box using an HDMI cable or HDMI cable with a DVI adapter, select **HDMI 1**, **HDMI 3**, or **HDMI 2**.
  - If your TV is connected to a cable or satellite box using a component video cable, select **Component**.
  - If your TV is connected to a cable or satellite box using a composite video cable, select **AV**.

# Understanding the basics

## Turning your TV on or off

**To turn your TV on or off:**

- 1 Make sure that the power cord is connected to your TV and a power outlet. See “[Connecting power](#)” on page 36.
- 2 Press **POWER** to turn on your TV. The power indicator turns blue.
- 3 Press **POWER** again to turn off your TV. Your TV enters standby mode, and the power indicator turns red.

**Warning**

When your TV is in standby mode, it is still receiving power. To completely disconnect power, unplug the power cord.

**Note**

If your TV does not receive an input signal for several minutes, it automatically goes into standby mode.

## Selecting the video input source

**To select the video input source:**

- 1 Turn on your TV, then press **INPUT**. The **INPUT SOURCE** list opens.

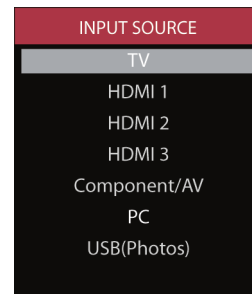

- 2 Press **▲** or **▼** to select a video input source, then press **ENTER**.

**Note**

The **INPUT SOURCE** list displays **Component** when a component video device is connected or displays **AV** when a composite video device is connected.

On-screen menu overview

**Notes**

- Depending on the signal source selected, you may see different options on your screen.
- Menu items that are not selectable are grayed out.
- Menus in this manual are described in TV mode, unless otherwise indicated.
- The screens shown in this manual are for explanation purposes and may vary from the actual screens on your TV.

SETUP menu (TV mode)

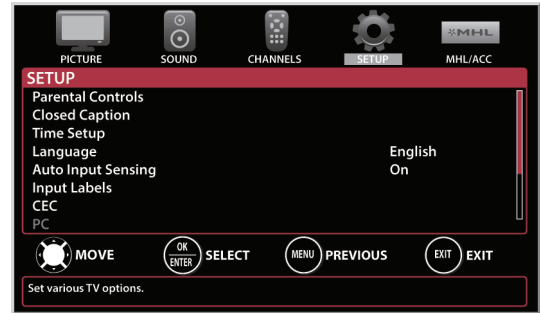

PHOTOS menu (USB mode)

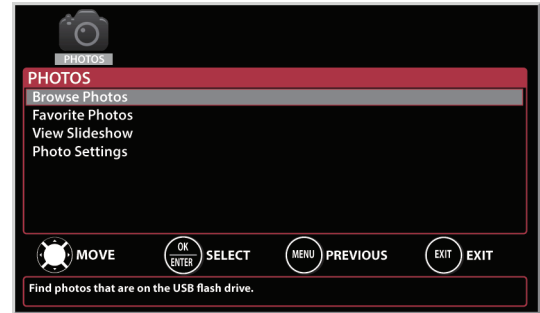

PICTURE menu (TV mode)

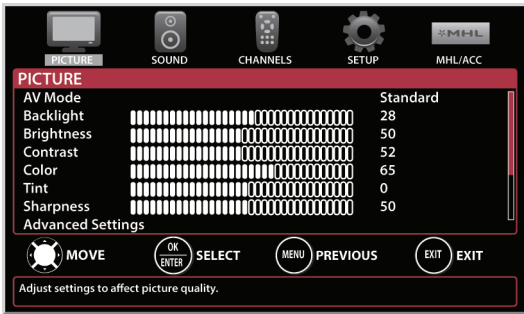

SOUND menu (TV mode)

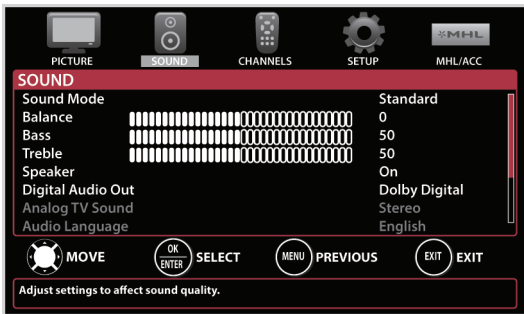

CHANNELS menu (TV mode)

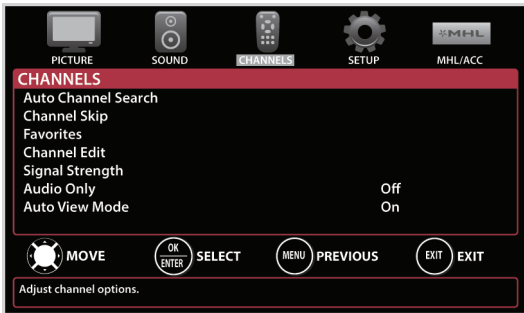

Navigating the menus

Press **MENU** to open the on-screen menu.

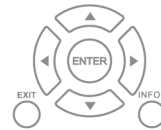

Press the right or left arrow to move the cursor on the screen or to adjust a selected item.



Press the up or down arrow to select menu options.



Press **ENTER** to confirm a selection or enter a sub-menu.



Press **MENU** to return to the previous menu.



Press **EXIT** to close the menu.



## Selecting a channel

### To select a channel:

- Press **CH**  $\wedge$  or **CH**  $\vee$  to go to the next or previous channel on the memorized channel list.
- Press the number buttons to enter the channel number you want, then wait for the channel to change or press **ENTER** to immediately change the channel.
- To select a digital sub-channel, press the number buttons to enter the main digital channel, press  $\bullet$  (sub-channel), then press the number button for the sub-channel. Wait for the channel to change, or press **ENTER** to immediately change the channel. For example, to tune to channel 5.1, press **5**,  $\bullet$  (sub-channel), then **1**.

#### Note

Button presses must be within three seconds of each other.

- Press **FLASHBACK** to go to the last viewed channel.
- Press **FAVORITE** to open the favorite channel list, press  $\blacktriangle$  or  $\blacktriangledown$  to highlight a channel, then press **ENTER**. For information about setting up a favorite channel list, see "[Setting up a favorite channel list](#)" on page 49.

#### Note

If a list has more than one page, press  $\blacktriangle$  or  $\blacktriangledown$  to scroll through the pages.

## Adjusting the volume

### To adjust the volume:

- Press **VOL+** or **VOL-** to increase or decrease the volume.
- Press  $\text{MUTE}$  to turn off the sound.  
Press  $\text{MUTE}$  again to turn the sound back on.

## Viewing channel information

### To view channel information:

- Press **INFO**\* to view an information banner. The information banner shows the current program information such as channel number, video input source, and resolution.
  - Digital channel information—Displays the channel number, station name, channel label, broadcast program name, TV rating, signal type, audio information, resolution, current time, signal strength, day of the week, date and current program start and end times, if provided by the broadcaster.
  - Analog channel information—Displays channel number, channel label, signal type, audio information, day of the week, date, and resolution, if provided by the broadcaster.



# Adjusting the picture

## Adjusting the TV picture

You can adjust various settings to improve the quality of the TV picture. Also, you can reset all picture settings to the factory default.

### To adjust the TV picture:

- 1 Press **MENU**. The on-screen menu opens with the *PICTURE* menu displayed.

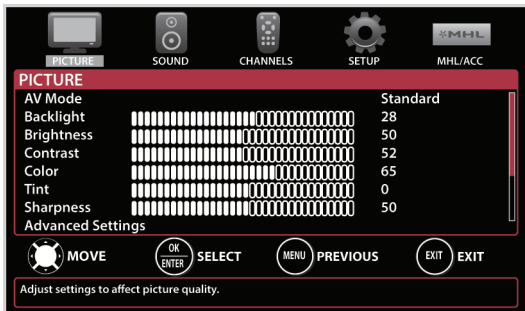

- 2 Press **▼** or **ENTER** to access the menu.
- 3 Press **▲** or **▼** to highlight an option, then press **ENTER** to access the option. You can select:
  - **AV Mode**—Selects the picture mode. You can select:
    - **Dynamic**—(a bright and vivid picture). Significantly increases the contrast, brightness, and sharpness. This selection is good for video games, animation, and in bright light environments.
    - **Natural**—(a standard picture). Moderately increases the contrast, brightness, and sharpness. This selection is good for standard TV broadcasts.
    - **Standard**—(the backlight brightness is decreased). Your TV has a backlight that provides light for displaying a picture. By reducing the amount of light, your TV uses less energy.
    - **Movie**—(a finely detailed picture). Adjusts the brightness and contrast and lowers the sharpness for a more realistic picture. This selection is good for watching the highest quality video such as Blu-ray Discs, DVDs, and HDTV.
    - **Game**—Adjusts the picture for the ultimate gaming experience. This option is available when the video input source is set the **HDMI**, **Component**, **AV**, or **VGA**.
    - **User**—(customized picture). Lets you manually adjust picture settings such as brightness, contrast, and sharpness.

**Note**  
You can also press **AV MODE** to select the picture mode.

- **Backlight**—Sets the overall brilliance of the screen.
- **Brightness**—Adjusts the brightness of the dark areas of the picture.
- **Contrast**—Adjusts the brightness of the light areas of the picture.

- **Color**—Adjusts the color intensity of the picture. A low setting may make the color look faded. A high setting may make the color look artificial.
- **Tint**—Adjusts the color balance of the picture. Use this control to make skin tones look more natural.
- **Sharpness**—Adjusts the color detail of images. If you set this control too high, dark images may appear with light or white edges.
- **Advanced Settings**—Opens the *PICTURE · ADVANCED SETTINGS* menu where you can adjust additional video options.

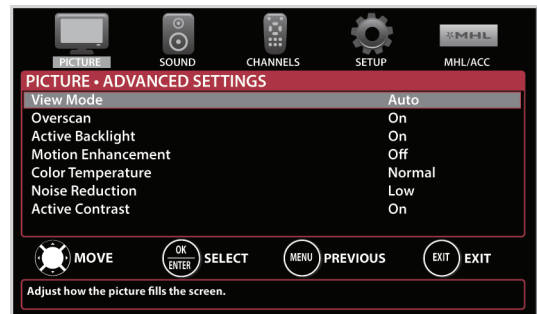

- **View Mode**—Adjusts how the picture fills the screen (aspect ratio). You can select:

Aspect ratio options	Example
<p><b>Normal:</b> Displays the image in the original aspect ratio. Black bars appear if the image is not in the widescreen (16:9) aspect ratio.</p>	
<p><b>Zoom:</b> Expands the image to fill the screen. The top and bottom of the image may be cropped.</p>	
<p><b>Wide:</b> Use this option to view content recorded in a 16:9 (widescreen) aspect ratio.</p>	
<p><b>Cinema:</b> Stretches the image at the edges, but keeps a clear image in the center.</p>	
<p><b>Auto:</b> Automatically adjusts the image based on the screen size and the TV program. <b>Note:</b> <b>Auto</b> is only available when <b>Auto View Mode</b> in the <i>CHANNELS</i> menu is set to <b>On</b>.</p>	

**Note**  
You can also press **VIEW MODE** to select the aspect ratio.



- **Overscan**—Extends text and images past the screen edges to hide edge artifacts. You can select **On** or **Off**.
  - **Active Backlight**—Enhances the contrast ratio between light and dark areas of the picture. You can select **On** or **Off**.
  - **Motion Enhancement**—Reduces motion blur and eliminates film judder with clear detail and smooth motion. You can select **Off**, **On (Low)**, **On (High)**, or **Film Mode**.
  - **Color Temperature**—Selects the color temperature. You can select **Cool** (to enhance the blues), **Normal**, or **Warm** (to enhance the reds).
  - **Noise Reduction**—Selects the noise reduction mode to reduce picture noise (snow). You can select **Off**, **Low**, **Middle**, or **High**.
  - **Active Contrast**—Automatically adjusts picture detail and brightness. You can select **On** or **Off**.
  - **Reset Picture Settings**—Resets all picture settings to factory mode.
- 4 Press ◀ or ▶ to adjust the option, or press ▲ or ▼ to select a setting.
  - 5 Press **MENU** to return to the previous menu, or press **EXIT** to close the menu.

## Setting the power on picture mode

You can set the picture mode your TV uses when you turn it on.

### To set the power on picture mode:

- 1 Press **MENU**. The on-screen menu opens.
- 2 Press ◀ or ▶ to highlight **SETUP**, then press ▼ or **ENTER**. The **SETUP** menu opens.

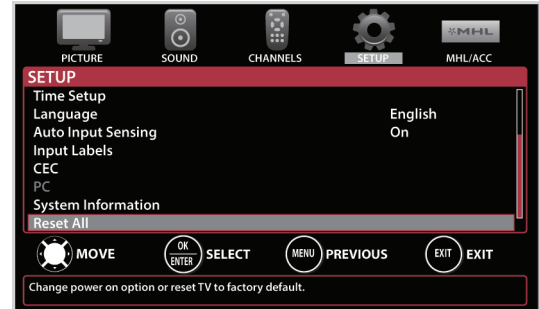

- 3 Press ▲ or ▼ to highlight **Reset All**, then press **ENTER**. The **SETUP · RESET ALL** menu opens.

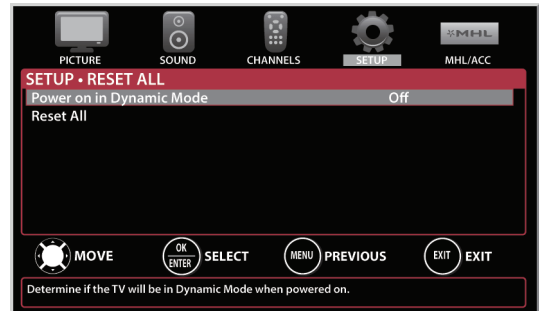

- 4 Press ▲ or ▼ to highlight **Power on in Dynamic Mode**, then press **ENTER**.
- 5 Press ▲ or ▼ to highlight **On** (when you turn on your TV, it will be in **Dynamic** picture mode) or **Off** (when you turn on your TV, it will be in the picture mode it was in before you turned it off), then press **ENTER**.
- 6 Press **MENU** to return to the previous menu, or press **EXIT** to close the menu.

## Adjusting the computer image

When you connect a computer to your TV using the **PC IN** jack, you may need to adjust the computer image to improve the quality.

### Note

The **PC** option is only available when a computer is connected to the **PC IN** jack on the back of your TV.

### To adjust the computer image:

- 1 Make sure that your TV is in PC mode. For more information, see "Selecting the video input source" on page 40.
- 2 Press **MENU**. The on-screen menu opens.
- 3 Press **◀** or **▶** to highlight **SETUP**, then press **ENTER**. The **SETUP** menu opens.

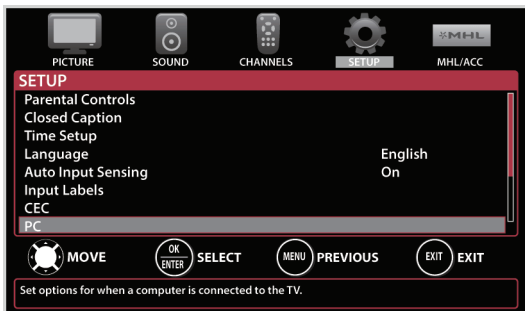

- 4 Press **▲** or **▼** to highlight **PC**, then press **ENTER**. The **SETUP · PC** menu opens.

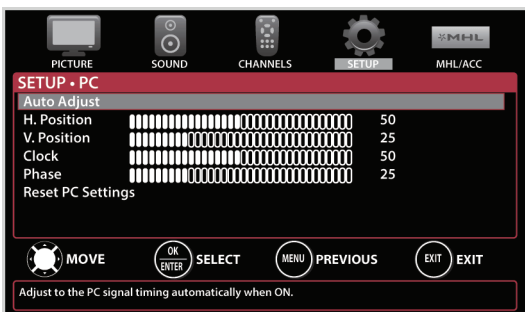

- 5 Press **▲** or **▼** to highlight an option, then press **ENTER** to access the option. You can select:
  - **Auto Adjust**—Automatically adjusts the image settings such as position and phase.
  - **H. Position**—Moves the image right or left.
  - **V. Position**—Moves the image up or down.
  - **Clock**—Minimizes vertical stripes in the screen image.
  - **Phase**—Adjusts the focus of stable images.
  - **Reset PC Settings**—Resets all computer settings to factory mode.
- 6 Press **◀** or **▶** to adjust the option, or press **▲** or **▼** to select a setting.
- 7 Press **MENU** to return to the previous menu, or press **EXIT** to close the menu.

## Adjusting the sound

### Adjusting sound settings

You can adjust sound settings to improve the sound quality. You also can reset all sound settings to the factory default.

### To adjust sound settings:

- 1 Press **MENU**. The on-screen menu opens.
- 2 Press **◀** or **▶** to highlight **SOUND**, then press **▼** or **ENTER**. The **SOUND** menu opens.

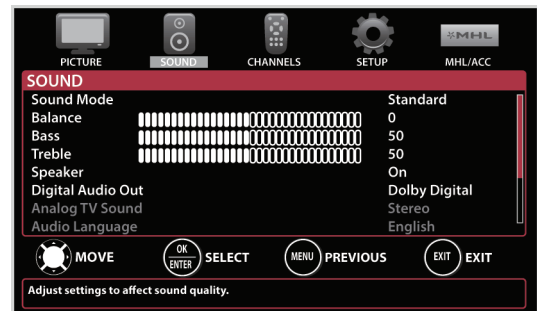

- 3 Press **▲** or **▼** to highlight an option, then press **ENTER** to access the option. You can select:
  - **Sound Mode**—Selects the sound mode. You can select:
    - **Standard**—Balances treble and bass. This setting is good for watching standard TV broadcasts.
    - **Movie**—Enhances treble and bass for a rich sound experience. This setting is good for watching DVDs, Blu-ray Discs, and HDTV.
    - **Music**—Preserves the original sound. This setting is good for listening to music.
    - **Voice**—Enhances vocals for TV audio. This setting is good for watching news broadcasts.
    - **User**—Lets you manually adjust sound settings.
  - **Balance**—Adjusts the balance between the left and right audio channels.
  - **Bass**—Adjusts the low sounds.
  - **Treble**—Adjusts the high sounds.
  - **Speaker**—Selects where the TV audio is played. You can select **On** (default setting) to play audio through the TV speakers, or select **Off** to turn off the TV speakers and play audio through a connected sound system.
  - **Digital Audio Out**—Sends digital audio to an external audio system. You can select:
    - **Dolby Digital**—Outputs the original digital audio sound.
    - **PCM**—Outputs audio in 2-channel stereo.
    - **Audio Delay**—Fine tunes the audio when it is not in sync with the video.

- **Analog TV Sound**—(Analog channels only)  
Selects the audio mode. You can select:
  - **Mono**—Select this option if there is noise or static on weak stereo broadcasts.
  - **Stereo**—Select this option for programs broadcast in stereo.
  - **SAP**—Select this option to listen to a secondary audio program, if available.

**Note**

You can also press **AUDIO** one or more times to select the audio mode.

- **Audio Language**—(Digital channels only)  
Selects an alternate audio language, if available.
  - **Headphones/Audio Out**—You can use the **⏻/AUDIO OUT** jack on the side of your TV to connect headphones, an amplifier, a home theater system, or a sound bar. When a device is connected to the **⏻/AUDIO OUT** jack, the TV speakers are muted. This option selects where the audio is played. You can select:
    - **Headphone**—Select this option if you connected headphones.
    - **Audio Out Fixed**—Select this option to use the remote control that came with the amplifier, home theater system, or sound bar you connected to the **⏻/AUDIO OUT** jack to control the audio.
    - **Audio Out Variable**—Select this option to use the remote control that came with your TV to control the audio from the amplifier, home theater system, or sound bar you connected to the **⏻/AUDIO OUT** jack.  
This option is only available when a device is connected to the **⏻/AUDIO OUT** jack.
  - **Reset Sound Settings**—Reset all audio settings to factory defaults.
- 4 Press **◀** or **▶** to adjust the option, or press **▲** or **▼** to select a setting.
  - 5 Press **MENU** to return to the previous menu, or press **EXIT** to close the menu.

**Selecting the audio out mode**

If your TV is on when you connect a device to the **⏻/AUDIO OUT** jack on the side of your TV, a screen opens where you select which audio out mode you want to use.

**To select the audio out mode:**

- 1 Connect headphones, an amplifier, a home theater system, or a sound bar to the **⏻/AUDIO OUT** jack on the side of your TV. The following screen opens.

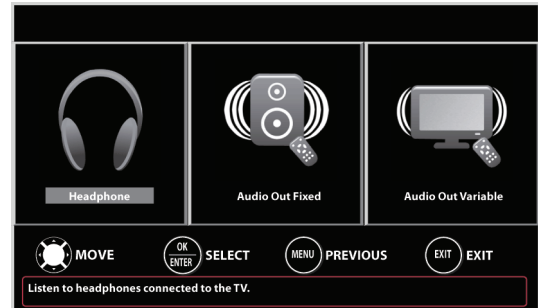

- 2 Press **◀** or **▶** to highlight the audio out mode you want to use, then press **ENTER**. You can select:
  - **Headphone**—Select this option if you connected headphones.
  - **Audio Out Fixed**—Select this option to use the remote control that came with the amplifier, home theater system, or sound bar you connected to the **⏻/AUDIO OUT** jack to control the audio.
  - **Audio Out Variable**—Select this option to use the remote control that came with your TV to control the audio from the amplifier, home theater system, or sound bar you connected to the **⏻/AUDIO OUT** jack.

### Playing TV audio only

You can turn off the picture on your TV and listen to the program audio only.

#### To play TV audio only:

- 1 Press **MENU**. The on-screen menu opens.
- 2 Press **◀** or **▶** to highlight **CHANNELS**, then press **▼** or **ENTER**. The **CHANNELS** menu opens.

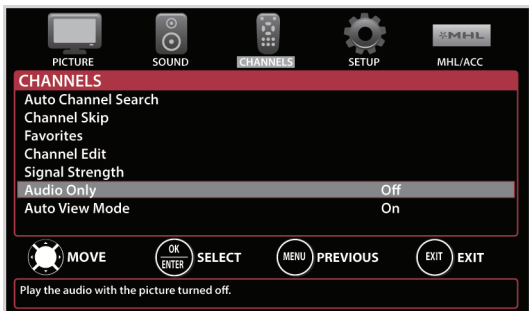

- 3 Press **▲** or **▼** to highlight **Audio Only**, then press **ENTER**.
- 4 Press **▲** or **▼** to select **On**.
- 5 Press **MENU** to return to the previous menu, or press **EXIT** to close the menu.

**Notes**

- The picture turns off in about five seconds.
- **Audio Only** works only when the input source is TV and your TV is receiving a broadcast signal.
- To exit audio only mode, press any button. When you exit audio only mode, the **Audio Only** option is automatically reset to **Off**.

## Changing channel settings

### Automatically scanning for channels

When you scan for channels, your TV searches for channels with signals and stores the channel information in the channel list. When you press **CH ▲** or **CH ▼**, your TV goes to the next or previous channel in the channel list.

If the TV signal source changes, for example you change from an outdoor antenna to cable TV (no box), you need to scan for channels.

### To automatically scan for channels:

- 1 Press **MENU**. The on-screen menu opens.
- 2 Press **◀** or **▶** to highlight **CHANNELS**, then press **▼** or **ENTER**. The **CHANNELS** menu opens.

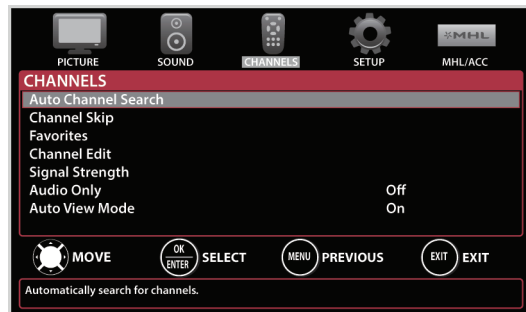

- 3 Press **▲** or **▼** to highlight **Auto Channel Search**, then press **ENTER**. The **CHANNELS · AUTO CHANNEL SEARCH** screen opens.

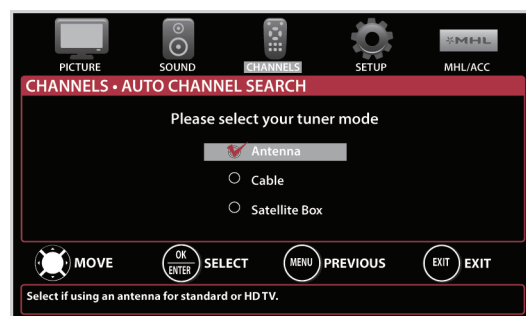

- 4 Press **▲** or **▼** to highlight **Antenna**, **Cable**, or **Satellite Box**, then press **ENTER**.
  - A If you select **Antenna**, your TV scans for available channels. The scan may take several minutes.

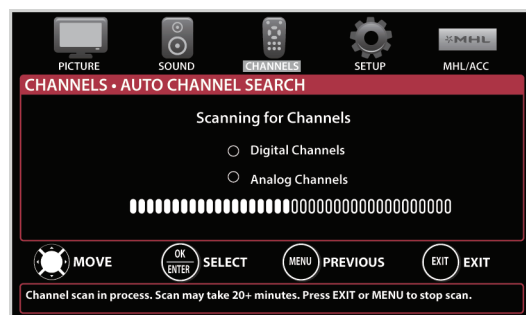

**Note**

You can press **EXIT** to stop the auto channel search, but you will need to run the auto channel search again to create a channel list.

**B** If you select **Cable**, a message asks if you have a cable box:

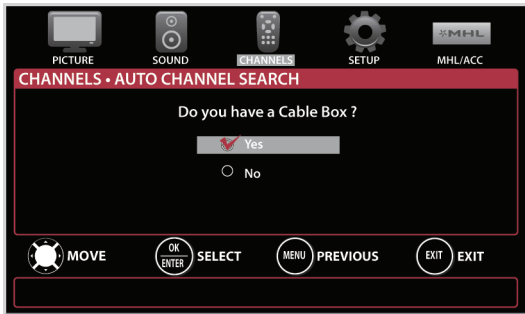

- Select **No**, then press **ENTER** if no cable box is connected. Your TV scans for available channels. The scan may take several minutes.
- Select **Yes**, then press **ENTER** if a cable box is connected. A message asks how you connected the cable box to your TV.

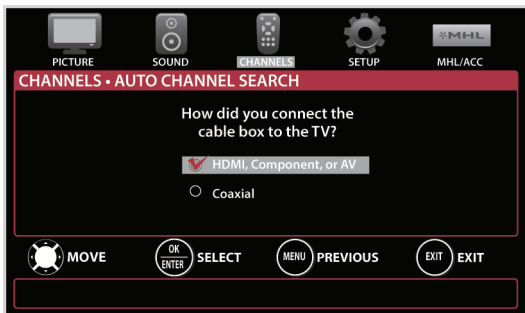

- Select **HDMI, Component, or AV**, then press **ENTER** if you connected a cable box to your TV using one of these cables. Read the message, then press **ENTER** to close the wizard.
- Select **Coaxial**, then press **ENTER** if you connected a cable box to your TV using a coaxial cable. Read the message, then press **ENTER** to start the channel scan (VHF channels only).

**Note**

You can press **EXIT** to stop the auto channel search, but you will need to run the auto channel search again to create a channel list.

**C** If you select **Satellite Box**, a message asks how you connected the satellite box to your TV:

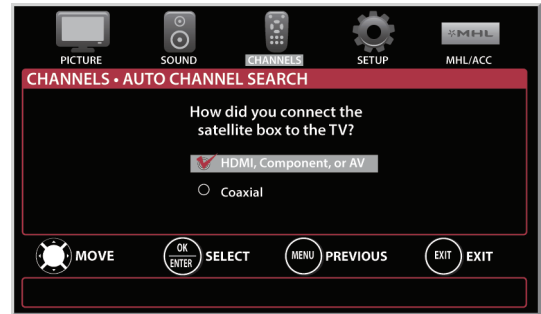

- Select **HDMI, Component, or AV**, then press **ENTER** if you connected a satellite box to your TV using one of these cables. Read the message, then press **ENTER** to close the wizard.
- Select **Coaxial**, then press **ENTER** if you connected a satellite box to your TV using a coaxial cable. Read the message, then press **ENTER** to start the channel scan (VHF channels only).

**Note**

You can press **EXIT** to stop the auto channel search, but you will need to run the auto channel search again to create a channel list.

### Hiding channels

You can hide channels in the channel list. When you press **CH**  $\wedge$  or **CH**  $\vee$ , your TV skips the hidden channels. You can still tune to a hidden channel by pressing the number buttons for the channel.

#### To hide channels:

- 1 Press **MENU**. The on-screen menu opens.
- 2 Press  $\leftarrow$  or  $\rightarrow$  to highlight **CHANNELS**, then press  $\nabla$  or **ENTER**. The **CHANNELS** menu opens.

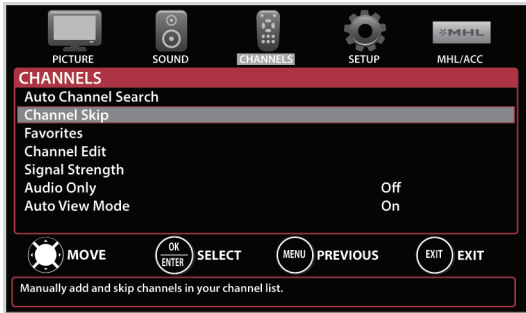

- 3 Press  $\blacktriangle$  or  $\blacktriangledown$  to highlight **Channel Skip**, then press **ENTER**. The **CHANNELS · CHANNEL SKIP** screen opens.

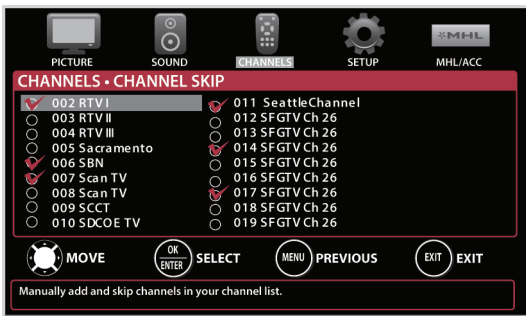

- 4 Press  $\blacktriangle$   $\blacktriangledown$   $\leftarrow$  or  $\rightarrow$  to highlight the channel you want to hide, then press **ENTER**. The check mark disappears.

#### Notes

- A channel with a check mark is not hidden. A channel with no check mark is hidden.
- If the list has more than one page, press  $\blacktriangle$  or  $\blacktriangledown$  to scroll through the pages.

- 5 Press **MENU** to return to the previous menu, or press **EXIT** to close the menu.

### Setting up a favorite channel list

You can create a favorite channel list so you can quickly browse through your favorite channels by pressing **FAVORITE**, then selecting a channel from the favorite channel list.

#### To set up a favorite channel list:

- 1 Press **MENU**. The on-screen menu opens.
- 2 Press  $\leftarrow$  or  $\rightarrow$  to highlight **CHANNELS**, then press  $\nabla$  or **ENTER**. The **CHANNELS** menu opens.

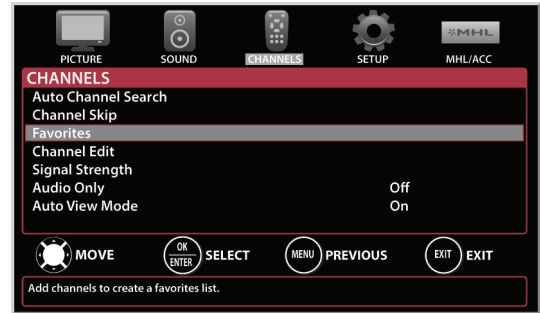

- 3 Press  $\blacktriangle$  or  $\blacktriangledown$  to highlight **Favorites**, then press **ENTER**. The **CHANNELS · FAVORITES** screen opens.

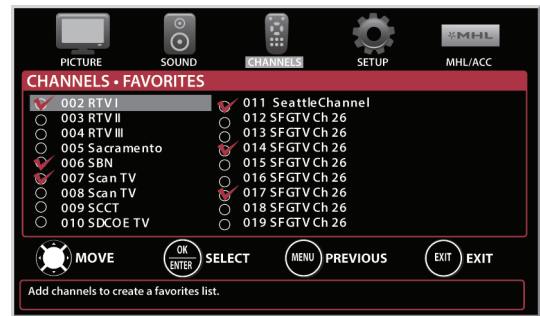

- 4 Press  $\blacktriangle$   $\blacktriangledown$   $\leftarrow$  or  $\rightarrow$  to highlight the channel you want to add to the favorites list, then press **ENTER**. A check mark appears next to the channel.

#### Notes

- To remove a channel from the favorites list, highlight the channel, then press **ENTER**. The check mark disappears and the channel is removed from the list.
- If the list has more than one page, press  $\blacktriangle$  or  $\blacktriangledown$  to scroll through the pages.

- 5 Press **MENU** to return to the previous menu, or press **EXIT** to close the menu.

### Viewing a favorite channel

#### To view a favorite channel:

- 1 Press **FAVORITE**. The favorite channel list opens.
- 2 Press  $\blacktriangle$  or  $\blacktriangledown$  to highlight a channel, then press **ENTER**.

### Adding or changing a channel label

If a channel is not already labeled, you can label the channel to make it easier to identify. You can also relabel a channel that is already labeled.

**To add or change a channel label:**

- 1 Press **MENU**. The on-screen menu opens.
- 2 Press **◀** or **▶** to highlight **CHANNELS**, then press **▼** or **ENTER**. The **CHANNELS** menu opens.

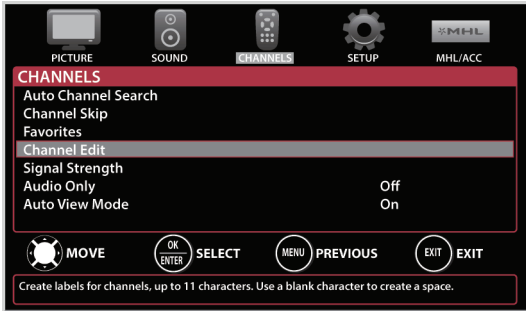

- 3 Press **▲** or **▼** to highlight **Channel Edit**, then press **ENTER**. The **CHANNELS · CHANNEL EDIT** screen opens with the channel number field highlighted.

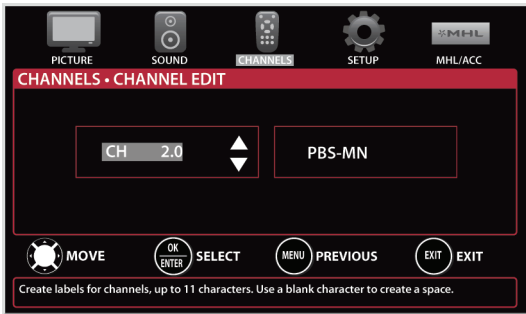

- 4 Press **▲** or **▼** to select the channel you want to label, then press **▶** to move to the channel label field.

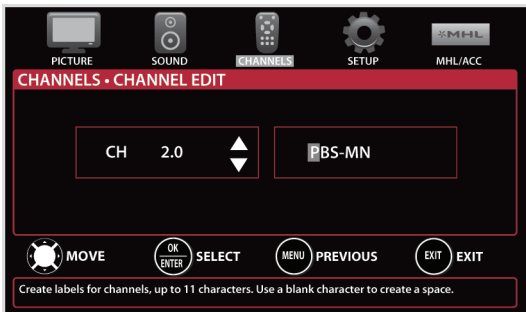

- 5 Press **▲** or **▼** to select a character, then press **◀** or **▶** to move to the previous or next character position. Repeat this step to enter additional characters. You can enter as many as 11 characters.
- 6 When you have completed the label, press **ENTER**.
- 7 Press **EXIT** to close the menu.

### Checking the digital signal strength

You can check the digital signal strength to determine if you need to adjust your antenna or digital cable input. The higher the signal strength, the less likely you are to experience picture degradation.

**To check the digital signal strength:**

- 1 Press **MENU**. The on-screen menu opens.
- 2 Press **◀** or **▶** to highlight **CHANNELS**, then press **▼** or **ENTER**. The **CHANNELS** menu opens.

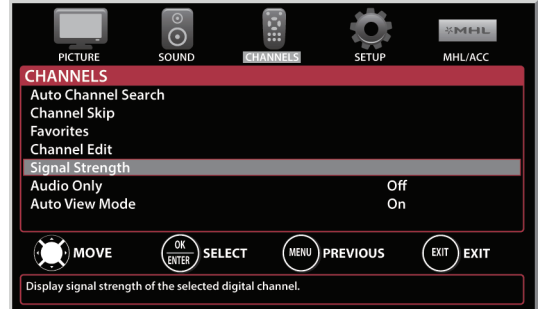

- 3 Press **▲** or **▼** to highlight **Signal Strength**, then press **ENTER**. The **Signal Strength** screen opens showing the signal strength meter.



- 4 Press **MENU** to return to the previous menu, or press **EXIT** to close the menu.



### Automatically adjusting the aspect ratio

**Auto View Mode** automatically changes how the picture looks on the screen (aspect ratio) based on the TV program you are viewing.

**To automatically adjust the aspect ratio:**

- 1 Press **MENU**. The on-screen menu opens.
- 2 Press **◀** or **▶** to highlight **CHANNELS**, then press **▼** or **ENTER**. The **CHANNELS** menu opens.

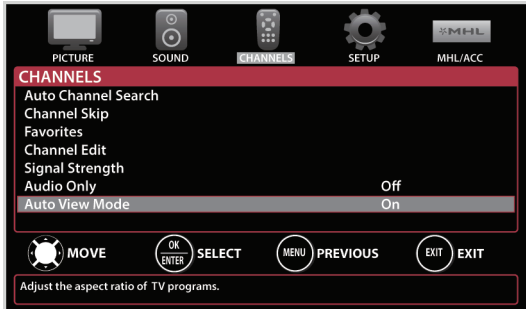

- 3 Press **▲** or **▼** to highlight **Auto View Mode**, then press **ENTER**.
- 4 Press **▲** or **▼** to select **On** (automatically adjust the aspect ratio) or **Off** (does not automatically adjust the aspect ratio), then press **ENTER**.
- 5 Press **MENU** to return to the previous menu, or press **EXIT** to close the menu.

**Note**  
You can also press **VIEW MODE** to select the aspect ratio.

## Setting parental controls

Parental controls let you prevent your children from watching inappropriate material on TV. When set, parental controls read the rating of the program (with some exceptions, such as news and sports) and deny access to programs that exceed the ratings level you select. To watch programs that exceed the selected rating, you must enter a password.

### Setting or changing the password

**To set or change the password:**

- 1 Press **MENU**. The on-screen menu opens.
- 2 Press **◀** or **▶** to highlight **SETUP**, then press **▼** or **ENTER**. The **SETUP** menu opens.

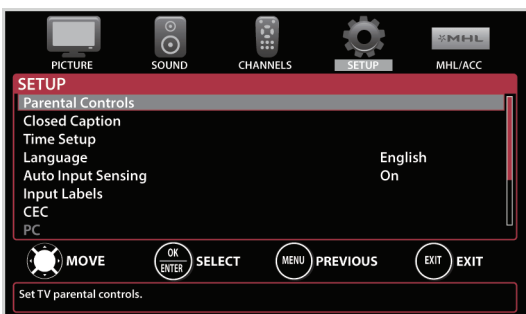

- 3 Press **▲** or **▼** to highlight **Parental Controls**, then press **ENTER**. The **Enter password** screen opens.

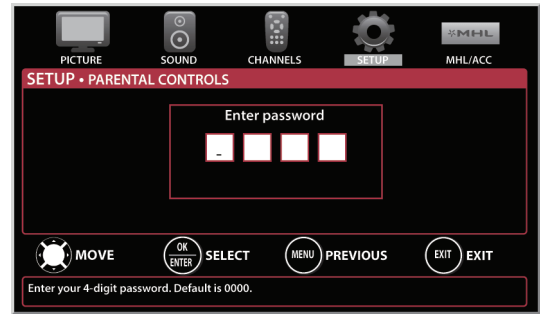

- 4 Press the number buttons to enter the four-digit password. The default password is **0000**. You should change the password to a number you can remember. The **SETUP · PARENTAL CONTROLS** menu opens.

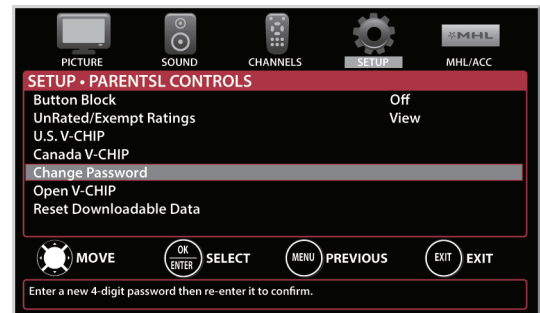

- 5 Press **▲** or **▼** to highlight **Change Password**, then press **ENTER**. The **SETUP · PARENTAL CONTROLS · CHANGE PASSWORD** screen opens.

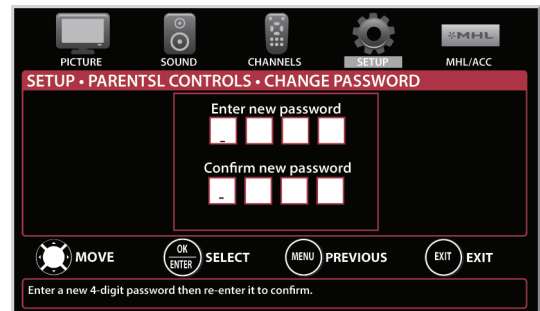

- 6 Press the number buttons to enter a password, then enter the password again. A message tells you that the password has been changed.

**Note**  
If you forget your password, enter **9999**.

- 7 Press **MENU** to return to the previous menu, or press **EXIT** to close the menu.



## Locking control buttons

When the button block is turned **On**, the buttons on the side of your TV are locked, and you can only operate your TV using the remote control.

### To lock control buttons:

- 1 Press **MENU**. The on-screen menu opens.
- 2 Press **◀** or **▶** to highlight **SETUP**, then press **▼** or **ENTER**. The **SETUP** menu opens.

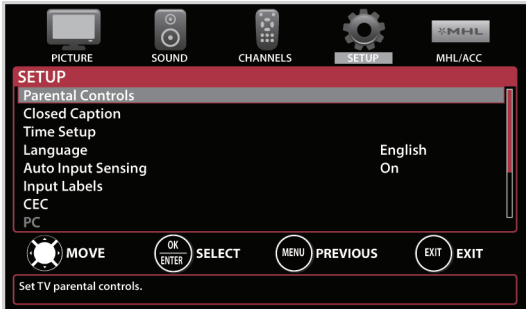

- 3 Press **▲** or **▼** to highlight **Parental Controls**, then press **ENTER**. The *Enter password* screen opens.

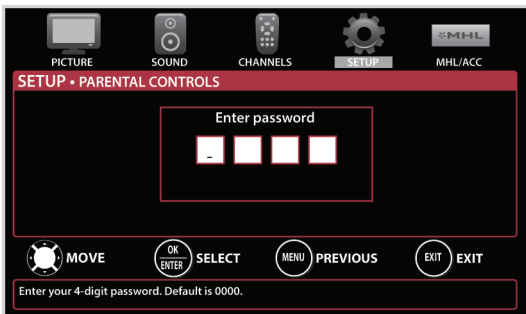

- 4 Press the number buttons to enter the four-digit password. The **SETUP · PARENTAL CONTROLS** menu opens.

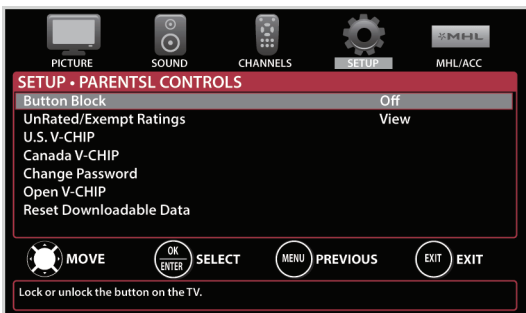

- 5 Press **▲** or **▼** to highlight **Button Block**, then press **ENTER**.
- 6 Press **▲** or **▼** to select **On** (locks the buttons) or **Off** (unlocks the buttons).
- 7 Press **MENU** to return to the previous menu, or press **EXIT** to close the menu.

## Blocking unrated TV

Some TV programs, such as news and sports shows are not rated. When you set **UnRated/Exempt Ratings** to **Block**, TV programs that do not have ratings are blocked. When you try to watch a blocked program, you are prompted to enter the parental controls password.

### To block unrated TV:

- 1 Press **MENU**. The on-screen menu opens.
- 2 Press **◀** or **▶** to highlight **SETUP**, then press **▼** or **ENTER**. The **SETUP** menu opens.

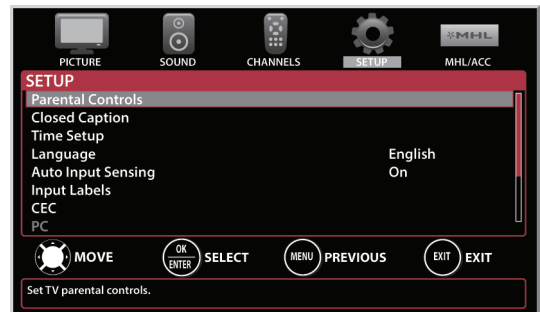

- 3 Press **▲** or **▼** to highlight **Parental Controls**, then press **ENTER**. The *Enter password* screen opens.

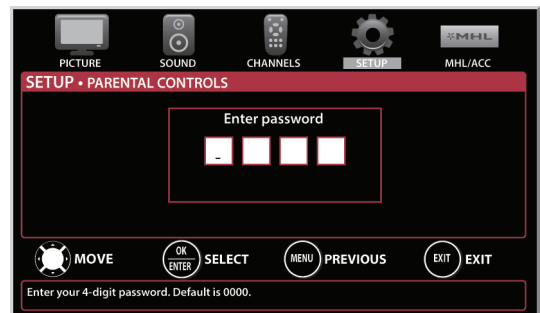

- 4 Press the number buttons to enter the four-digit password. The **SETUP · PARENTAL CONTROLS** menu opens.

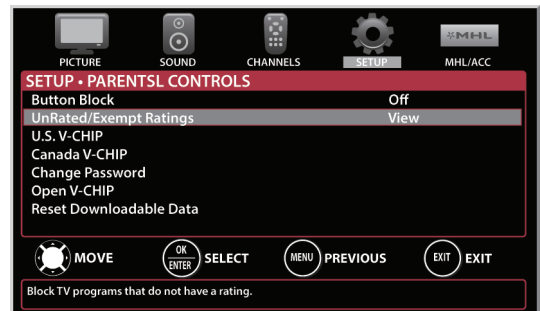

- 5 Press **▲** or **▼** to highlight **UnRated/Exempt Ratings**, then press **ENTER**.
- 6 Press **▲** or **▼** to select **Block** (to block unrated TV) or **View** (to unblock unrated TV).
- 7 Press **MENU** to return to the previous menu, or press **EXIT** to close the menu.

**Setting parental control levels**

You can set parental controls for the U.S. and Canada.

**U.S. rating levels**

U.S. TV ratings	
NONE	Not rated
TV-Y	All children
TV-Y7	Suitable for children 7 and older
TV-G	General audiences
TV-PG	Parental guidance suggested
TV-14	Parental guidance strongly suggested
TV-MA	Mature audiences only

Some of the age-based TV Parental Guidelines ratings also have content-based ratings.

U.S. TV content ratings	
All	All ratings are blocked
FV	Fantasy violence
L	Strong language
S	Sexual situations
V	Violence
D	Suggestive dialog

U.S. movie (MPAA) ratings	
None	Movie not rated
G	General audiences
PG	Parental guidance suggested
PG-13	Suitable for children 13 and older
R	Parental guidance suggested for children under 17
NC-17	Not suitable for children under 17
X	Adults only

**Canadian rating levels**

Canadian English ratings	
E	Exempt programming
C	Suitable for all children
C8+	Suitable for children 8 and older
G	General audiences
PG	Parental guidance suggested
14+	Suitable for children 14 and older
18+	Adult only

Canadian French ratings	
E	Exempt programming
G	General audiences
8ans+	Suitable for children 8 and older
13ans+	Suitable for children 13 and older
16ans+	Suitable for children 16 and older
18ans+	Adult only

**To set parental control levels:**

- 1 Press **MENU**. The on-screen menu opens.
- 2 Press **◀** or **▶** to highlight **SETUP**, then press **▼** or **ENTER**. The **SETUP** menu opens.

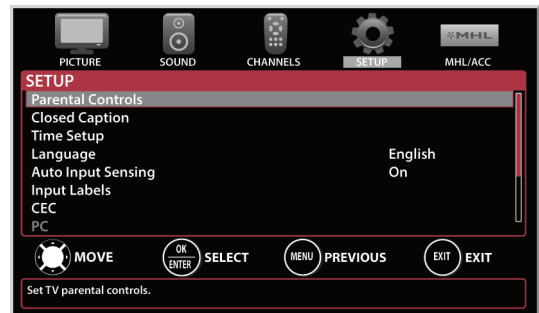

- 3 Press **▲** or **▼** to highlight **Parental Controls**, then press **ENTER**. The *Enter password* screen opens.

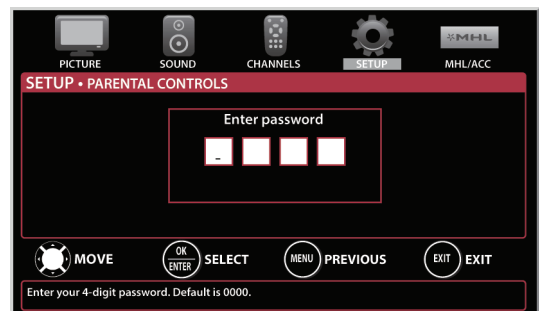

- 4 Press the number buttons to enter the four-digit password. The **SETUP · PARENTAL CONTROLS** menu opens.

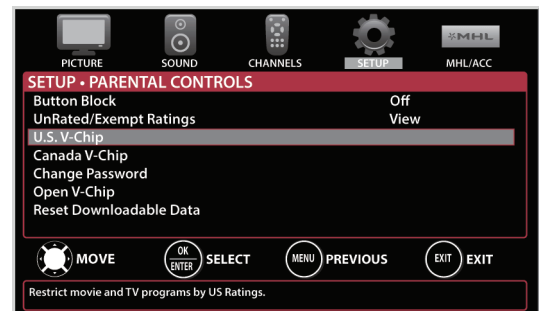

- Press **▲** or **▼** to highlight **U.S. V-CHIP**, then press **ENTER**. (To set Canadian ratings, select **Canada V-CHIP**.)

**U.S. V-CHIP**

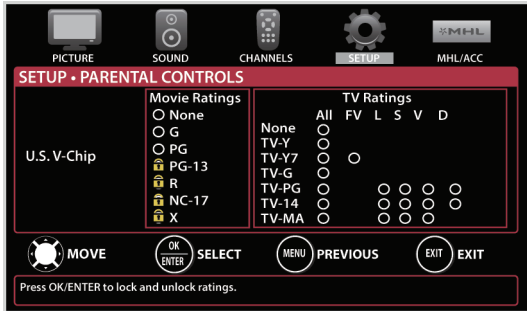

**Canada V-CHIP**

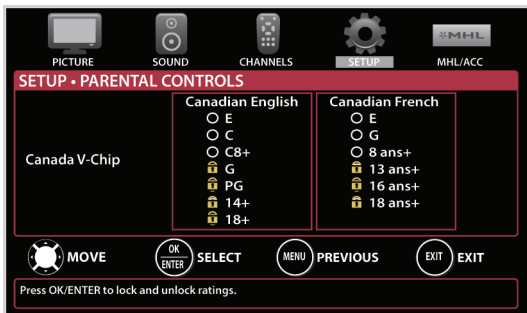

- Press **◀** or **▶** to highlight:
  - **Movie Ratings** or **TV Ratings** for USA ratings.
  - **Canadian English** or **Canadian French** for Canadian ratings.
- Press **▲** or **▼** to select the rating. If a rating has sub-ratings, press **◀** or **▶** to highlight a sub-rating.

**Note**  
When you block a rating, that rating and all higher ratings are blocked.

- Press **ENTER** to confirm. A lock symbol appears when a rating is blocked.
- Press **MENU** to return to the previous menu, or press **EXIT** to close the menu.

**Downloading rating information**

If the program you are viewing has downloadable rating information, you can download the information to use when setting parental controls.

**Note**  
If the program you are viewing does not have V-Chip rating information, **Open V-CHIP** is grayed on the **SETUP · PARENTAL CONTROLS** menu and cannot be selected.

**To download rating information:**

- Press **MENU**. The on-screen menu opens.
- Press **◀** or **▶** to highlight **SETUP**, then press **▼** or **ENTER**. The **SETUP** menu opens.

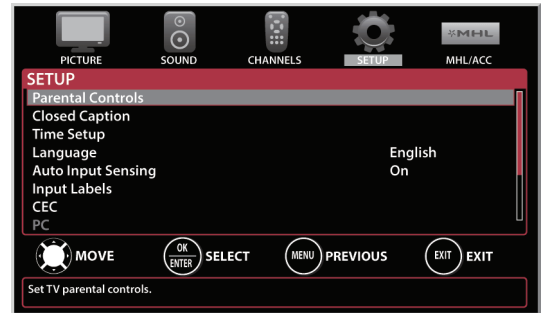

- Press **▲** or **▼** to highlight **Parental Controls**, then press **ENTER**. The *Enter password* screen opens.

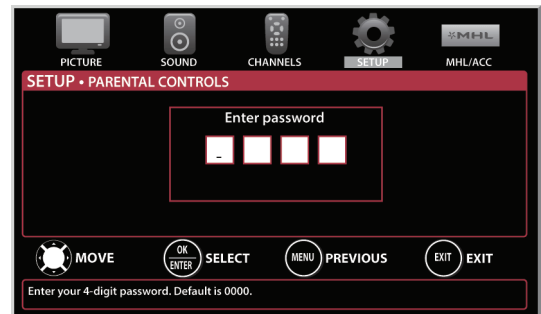

- Press the number buttons to enter the four-digit password. The **SETUP · PARENTAL CONTROLS** menu opens.

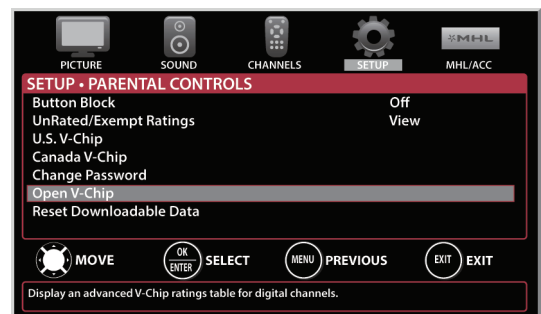

- Press **▲** or **▼** to highlight **Open V-CHIP**, then press **ENTER**. The **SETUP · PARENTAL CONTROLS · OPEN V-CHIP** screen opens. The screen that you see may vary depending on the broadcaster.

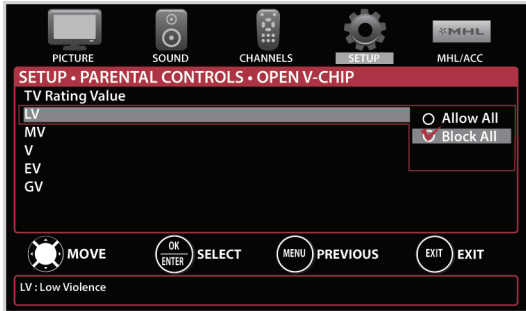

- Press **▲**, **▼**, **◀** or **▶** to select the program and content types you want to block, then press **ENTER**. The **SETUP · PARENTAL CONTROLS** menu opens.

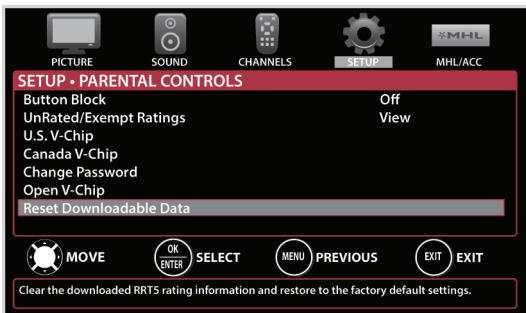

- To reset the V-Chip information to the factory default, press **▲** or **▼** to highlight **Reset Downloadable Data**, then press **ENTER**. A box opens.
- Press **▲** or **▼** to highlight **OK** or **Cancel**, then press **ENTER**.
- Press **MENU** to return to the previous menu, or press **EXIT** to close the menu.

## Using closed captioning

Closed captioning displays a text version of the TV program audio or displays information provided by the broadcaster.

### Turning closed captioning on or off

**To turn closed captioning on or off:**

- Press **MENU**. The on-screen menu opens.
- Press **◀** or **▶** to highlight **SETUP**, then press **▼** or **ENTER**. The **SETUP** menu opens.

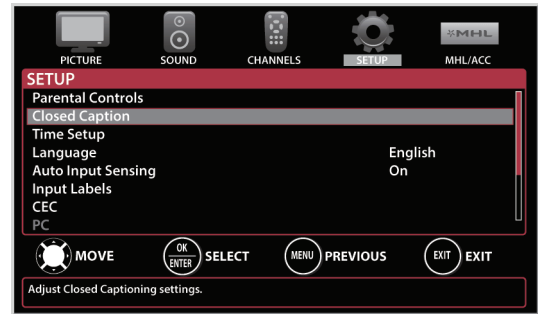

- Press **▲** or **▼** to highlight **Closed Caption**, then press **ENTER**. The **SETUP · CLOSED CAPTION** menu opens.

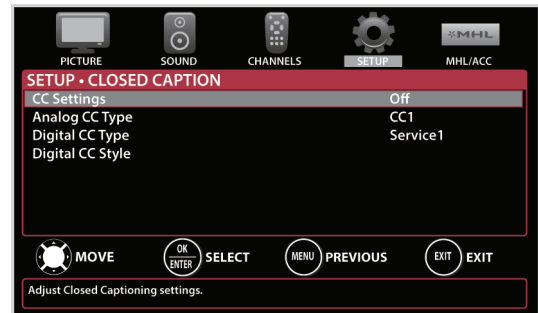

- Press **▲** or **▼** to highlight **CC Settings**, then press **ENTER**. A menu opens.
- Press **▲** or **▼** to select **Off** (turns off closed captioning), **On Always** (turns on closed captioning), or **On When Mute** (turns on closed captioning when the sound is muted).
- Press **MENU** to return to the previous menu, or press **EXIT** to close the menu.

#### Note

You can also press **CC** to turn closed captioning on or off.

### Selecting the analog closed captioning mode

Analog channels usually have one or more closed captioning modes. The CC1 mode usually displays a text version of the TV program audio in a small banner. The other CC modes display information provided by the broadcaster. The Text modes display information in a box that covers half of the screen.

**To select the analog closed captioning mode:**

- 1 Press **MENU**. The on-screen menu opens.
- 2 Press **◀** or **▶** to highlight **SETUP**, then press **▼** or **ENTER**. The *SETUP* menu opens.

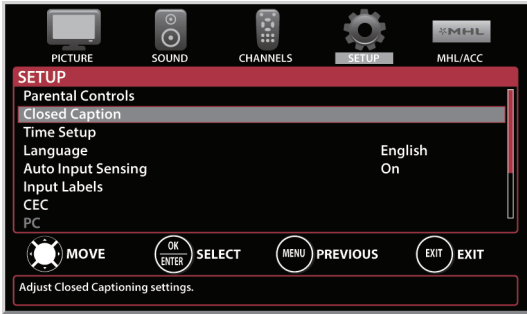

- 3 Press **▲** or **▼** to highlight **Closed Caption**, then press **ENTER**. The *SETUP · CLOSED CAPTION* menu opens.

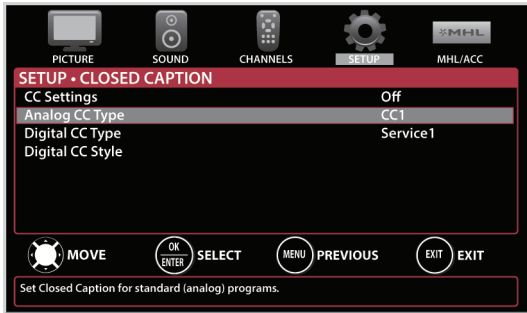

- 4 Press **▲** or **▼** to highlight **Analog CC Type**, then press **ENTER**. A menu opens.
- 5 Press **▲** or **▼** to select an analog caption setting. You can select:
  - **CC1** through **CC4**—Closed captioning appears in a small banner across the bottom of the screen. **CC1** is usually the “printed” version of the audio. **CC2** through **CC4** display content provided by the broadcaster.
  - **Text1** through **Text4**—Closed captioning covers half or all of the screen. **Text1** through **Text4** display content provided by the broadcaster.
- 6 Press **MENU** to return to the previous menu, or press **EXIT** to close the menu.

### Selecting the digital closed captioning mode

Digital channels usually have one or more closed captioning modes. The Service1 and CC1 modes usually display a text version of the TV program audio in a small banner. The other Service and CC modes display information provided by the broadcaster. Services1 mode displays a text version of the audio in the same language as the audio.

**To select the digital closed captioning mode:**

- 1 Press **MENU**. The on-screen menu opens.
- 2 Press **◀** or **▶** to highlight **SETUP**, then press **▼** or **ENTER**. The *SETUP* menu opens.

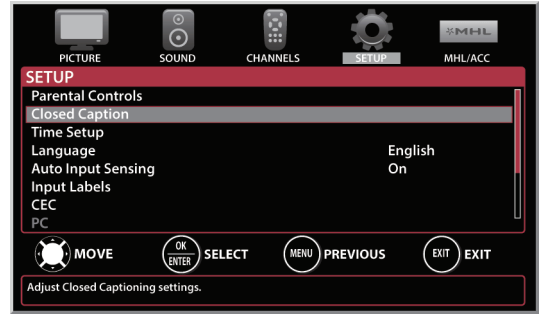

- 3 Press **▲** or **▼** to highlight **Closed Caption**, then press **ENTER**. The *SETUP · CLOSED CAPTION* menu opens.

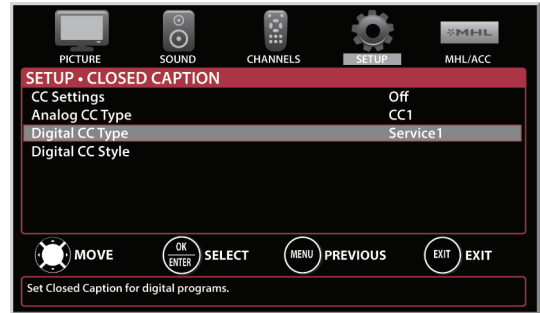

- 4 Press **▲** or **▼** to highlight **Digital CC Type**, then press **ENTER**. A menu opens.
- 5 Press **▲** or **▼** to select a digital caption setting. You can select:
  - **Service1** through **Service6**—Service1 is usually the “printed” version of the audio. Service2 through Service6 display content provided by the broadcaster. You can change the way digital closed captioning is displayed on the screen. For more information, see “[Customizing digital closed captioning settings](#)” on page 57.
  - **CC1** through **CC4**—Closed captioning appears in a small banner across the bottom of the screen. **CC1** is usually the “printed” version of the audio. **CC2** through **CC4** display content provided by the broadcaster.
- 6 Press **MENU** to return to the previous menu, or press **EXIT** to close the menu.

## Customizing digital closed captioning settings

### To customize digital closed captioning styles:

- 1 Press **MENU**. The on-screen menu opens.
- 2 Press **◀** or **▶** to highlight **SETUP**, then press **▼** or **ENTER**. The *SETUP* menu opens.

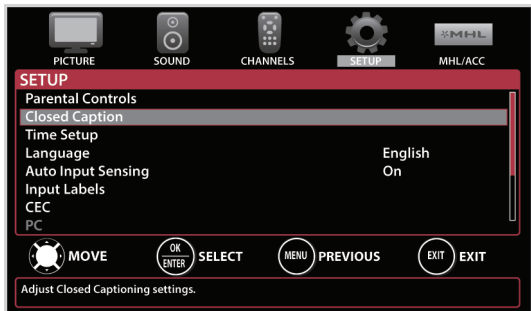

- 3 Press **▲** or **▼** to highlight **Closed Caption**, then press **ENTER**. The *SETUP · CLOSED CAPTION* menu opens.

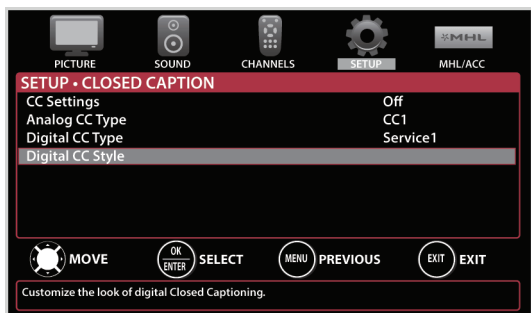

- 4 Press **▲** or **▼** to highlight **Digital CC Style**, then press **ENTER**. The *SETUP · CLOSED CAPTION · DIGITAL CC Style* menu opens with **Caption Style** highlighted.

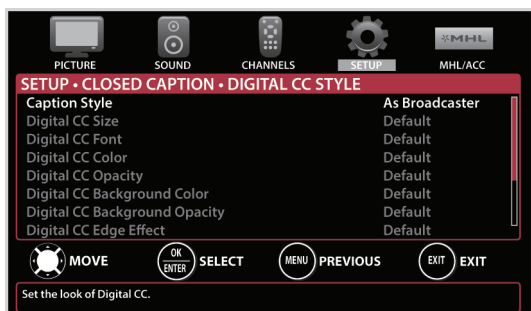

- 5 Press **ENTER**, then press **▲** or **▼** to select **Custom**.
- 6 Press **▲** or **▼** to highlight an option, then press **ENTER**. You can select:
  - **Digital CC Size**—Selects the font size.
  - **Digital CC Font**—Selects the font style.
  - **Digital CC Color**—Selects the color for the words.
  - **Digital CC Opacity**—Selects the opacity level for the words.
  - **Digital CC Background Color**—Selects the color for the background.
  - **Digital CC Background Opacity**—Selects the opacity level for the background.
  - **Digital CC Edge Effect**—Selects the style of the letter edges.
  - **Digital CC Edge Color**—Selects the color of the letter edges.
- 7 Press **▲** or **▼** to select a setting, then press **ENTER**.
- 8 Press **MENU** to return to the previous menu, or press **EXIT** to close the menu.

# Adjusting time settings

When you set up your TV for the first time, the clock was set up. If the power is disconnected or you move your TV to a different time zone, you need to reset the clock to the correct time.

## Setting the clock

To set the clock:

- 1 Press **MENU**. The on-screen menu opens.
- 2 Press **◀** or **▶** to highlight **SETUP**, then press **▼** or **ENTER**. The **SETUP** menu opens.

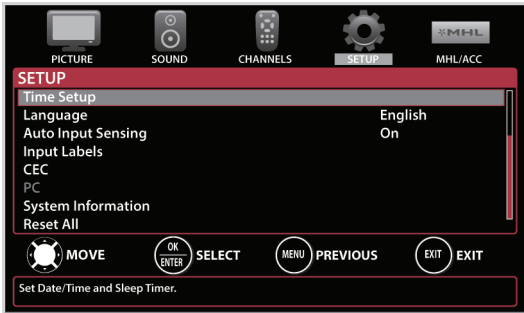

- 3 Press **▲** or **▼** to highlight **Time Setup**, then press **ENTER**. The **SETUP · TIME SETUP** menu opens.

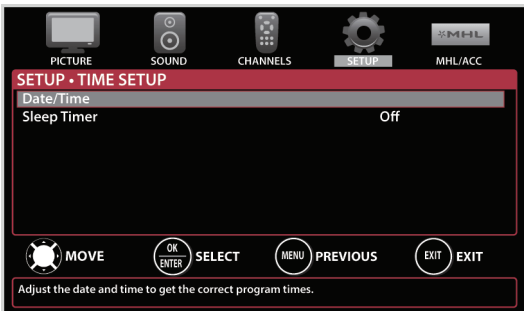

- 4 Press **▲** or **▼** to highlight **Date/Time**, then press **ENTER**. The **SETUP · TIME SETUP · DATE/TIME** menu opens.

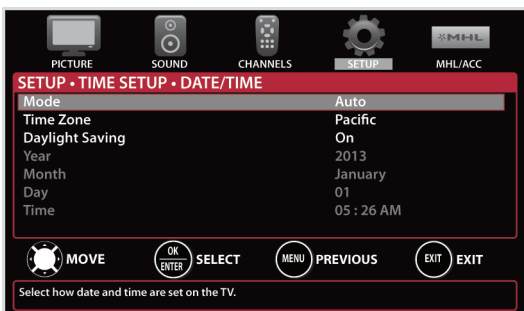

- 5 Press **▲** or **▼** to highlight **Mode**, then press **ENTER**. A menu opens.
- 6 Press **▲** or **▼** to highlight **Manual** (to set the options manually) or **Auto** (the options are automatically set by the TV signal source), then press **ENTER**.

- 7 Press **▲** or **▼** to highlight **Time Zone**, then press **ENTER**.
- 8 Press **▲** or **▼** to select your time zone, then press **ENTER**. You can select **Eastern, Central, Mountain, Pacific, Alaska, Hawaii, Atlantic, or Newfoundland**.
- 9 If your viewing area observes Daylight Saving Time, press **▲** or **▼** to highlight **Daylight Saving**, then press **ENTER**.
- 10 Press **▲** or **▼** to select **On** or **Off**, then press **ENTER** to close the menu.
- 11 If you selected **Manual** for **Mode**:
  - Press **▲** or **▼** to highlight **Year, Month, or Day**, then press **▶** to access the setting. Press **▲** or **▼** to adjust the setting, then press **ENTER**.
  - Press **▲** or **▼** to highlight **Time**, then press **▶** to access the setting. Press **◀** or **▶** to highlight the hour, minute, or AM/PM field, then press **▲** or **▼** to adjust the setting. When you are finished, press **ENTER**.
- 12 Press **MENU** to return to the previous menu, or press **EXIT** to close the menu.



## Setting the sleep timer

You can specify the amount of time before your TV automatically turns off.

### To set the sleep timer:

- 1 Press **MENU**. The on-screen menu opens.
- 2 Press **◀** or **▶** to highlight **SETUP**, then press **▼** or **ENTER**. The **SETUP** menu opens.

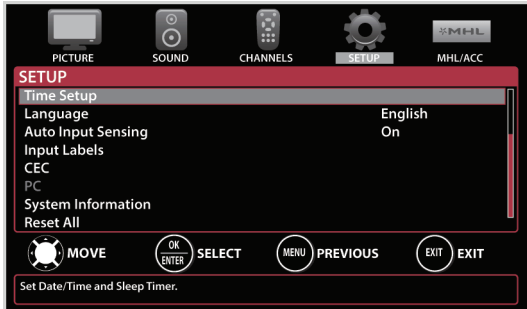

- 3 Press **▲** or **▼** to highlight **Time Setup**, then press **ENTER**. The **SETUP · TIME SETUP** menu opens.

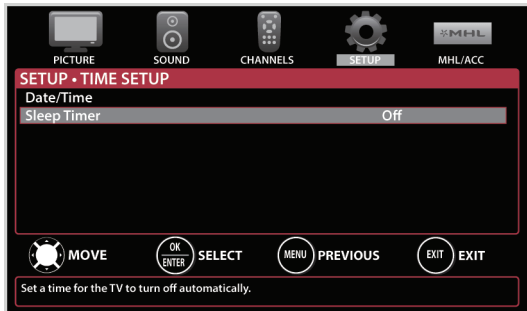

- 4 Press **▲** or **▼** to highlight **Sleep Timer**, then press **ENTER**. A menu opens.
- 5 Press **▲** or **▼** to select the amount of time before your TV turns off automatically. You can select **Off, 5 minutes, 10 minutes, 15 minutes, 30 minutes, 60 minutes, 90 minutes, 120 minutes, 180 minutes, or 240 minutes**. To turn off the sleep timer, select **Off**.
- 6 Press **MENU** to return to the previous menu, or press **EXIT** to close the menu.

### Note

You can also press **SLEEP** to set the sleep timer.

## Adjusting menu settings

### Selecting the menu language

Your TV can display the on-screen menu in English, French, or Spanish. When you set your TV up for the first time, the language was selected. You can change the menu language to a different language.

#### To select the menu language:

- 1 Press **MENU**. The on-screen menu opens.
- 2 Press **◀** or **▶** to highlight **SETUP**, then press **▼** or **ENTER**. The **SETUP** menu opens.

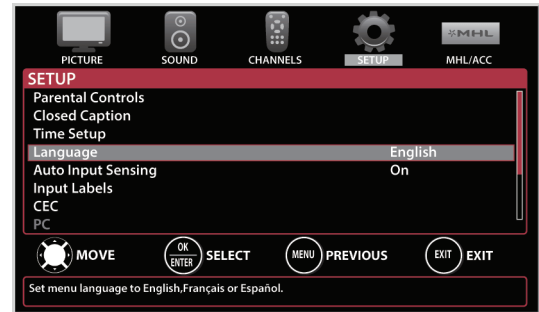

- 3 Press **▲** or **▼** to highlight **Language**, then press **ENTER**. A menu opens.
- 4 Press **▲** or **▼** to highlight a language, then press **ENTER**. You can select **English, Français, or Español**.
- 5 Press **MENU** to return to the previous menu, or press **EXIT** to close the menu.

### Turning Input Sensor on or off

When the Input Sensor feature is turned on, your TV automatically detects which video jacks have devices connected to them. Your TV uses this information to determine what options you can select on the **INPUT SOURCE** list when you press **INPUT**.

#### To turn Input Sensor on or off:

- 1 Press **MENU**. The on-screen menu opens.
- 2 Press **◀** or **▶** to highlight **SETUP**, then press **▼** or **ENTER**. The **SETUP** menu opens.

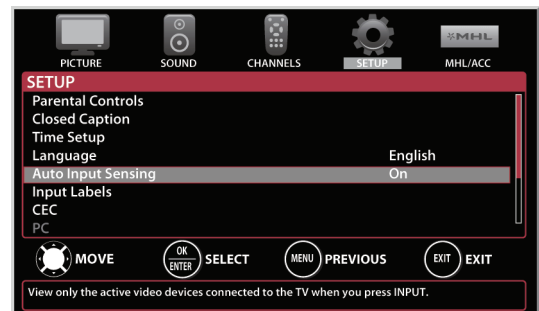

- 3 Press **▲** or **▼** to highlight **Auto Input Sensing**, then press **ENTER**. A menu opens.
- 4 Press **▲** or **▼** to select **On** (turns on the input sensor) or **Off** (turns off the input sensor).
- 5 Press **MENU** to return to the previous menu, or press **EXIT** to close the menu.



## Labeling an input source

You can add a label to an input source to make it easier to identify in the *INPUT SOURCE* list.

### To label an input source:

- 1 Press **MENU**. The on-screen menu opens.
- 2 Press **◀** or **▶** to highlight **SETUP**, then press **▼** or **ENTER**. The *SETUP* menu opens.

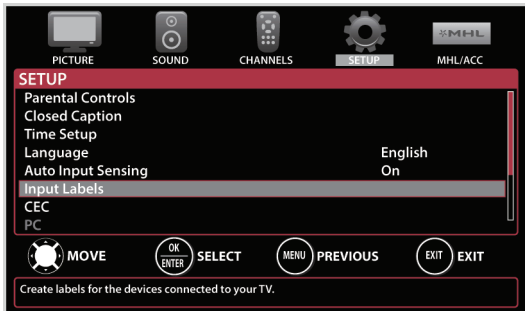

- 3 Press **▲** or **▼** to highlight **Input Labels**, then press **ENTER**. The *SETUP · INPUT LABELS* screen opens with the input source field highlighted.

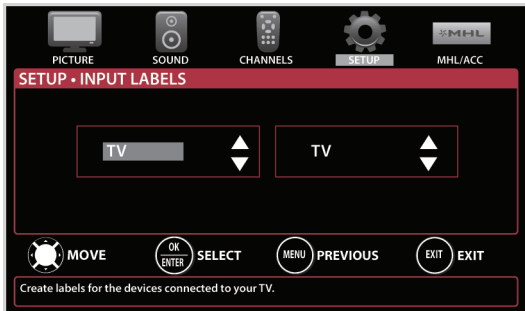

- 4 Press **▲** or **▼** to select the input source you want to label, then press **▶** to move to the label field.

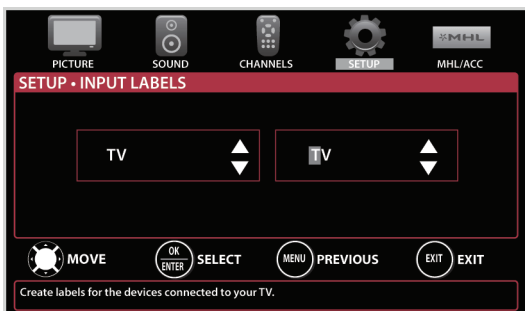

- 5 Press **▲** or **▼** to select a character, then press **◀** or **▶** to move to the previous or next character position. Repeat this step to enter additional characters.
- 6 When you have completed the label, press **ENTER** to save your label and return to the previous menu. The next time you press **INPUT**, your label appears in the *INPUT SOURCE* list.
- 7 Press **EXIT** to close the menu.

## Using CEC Control

CEC Control lets you control HDMI CEC-compatible devices connected to the HDMI jacks on your TV using the remote control that came with your TV. To use CEC Control, you must set the **CEC Control** setting on the *SETUP · CEC* menu to **On**.

### Notes

- HDMI cables must be used to connect HDMI CEC-compatible devices to your TV.
- The connected device's HDMI CEC feature must be turned on.
- If you connect an HDMI device that is not HDMI CEC-compatible, all of the **CEC** features do not work.
- Depending on the connected HDMI device, the **CEC** feature may not work.

### Turning CEC Control on or off

#### To turn CEC Control on or off:

- 1 Press **MENU**. The on-screen menu opens.
- 2 Press **◀** or **▶** to highlight **SETUP**, then press **▼** or **ENTER**. The *SETUP* menu opens.

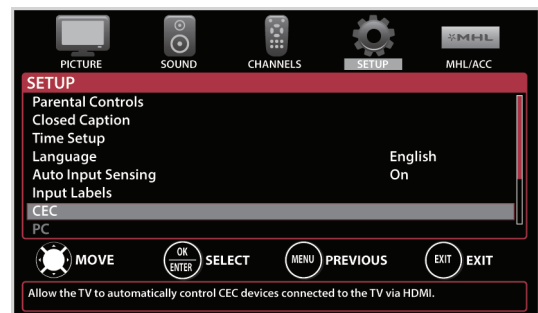

- 3 Press **▲** or **▼** to highlight **CEC**, then press **ENTER**. The *SETUP · CEC* menu opens.

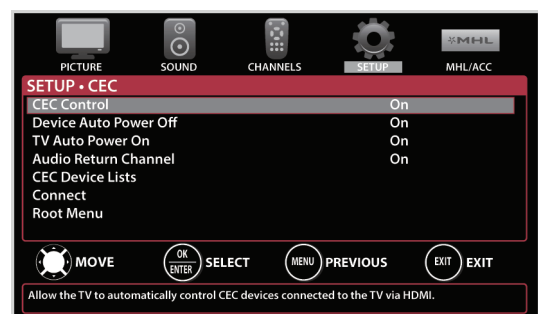

- 4 Press **▲** or **▼** to highlight **CEC Control**, then press **ENTER**.
- 5 Press **▲** or **▼** to highlight **On** or **Off**, then press **ENTER**.
- 6 Press **MENU** to return to the previous menu, or press **EXIT** to close the menu.

### Turning Device Auto Power Off on or off

When CEC Control is set to **On**, **Device Auto Power Off** automatically turns off HDMI CEC devices when you turn off your TV.

**To turn Device Auto Power Off on or off:**

- 1 Press **MENU**. The on-screen menu opens.
- 2 Press **◀** or **▶** to highlight **SETUP**, then press **▼** or **ENTER**. The *SETUP* menu opens.

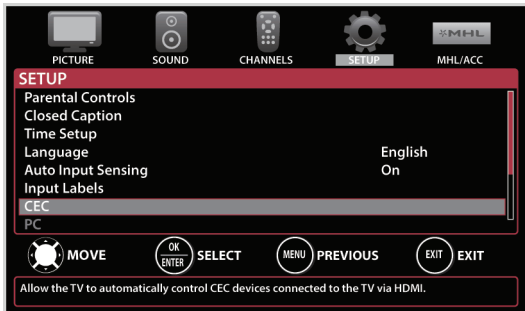

- 3 Press **▲** or **▼** to highlight **CEC**, then press **ENTER**. The *SETUP · CEC* menu opens.

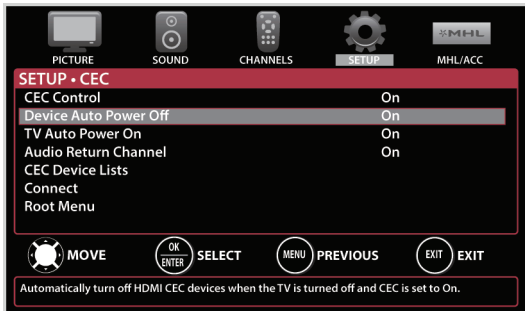

- 4 Make sure that the **CEC Control** option is turned on. See "Turning CEC Control on or off" on page 60.
- 5 On the *SETUP · CEC* menu, press **▲** or **▼** to highlight **Device Auto Power Off**, then press **ENTER**.
- 6 Press **▲** or **▼** to highlight **On** (turns off the connected devices when you turn off your TV) or **Off** (does not turn off the connected devices when you turn off your TV), then press **ENTER**.
- 7 Press **MENU** to return to the previous menu, or press **EXIT** to close the menu.

### Turning TV Auto Power On on or off

**TV Auto Power On** automatically turns on your TV when an HDMI CEC device is turned on, if the device has this feature.

**To turn TV Auto Power On on or off:**

- 1 Press **MENU**. The on-screen menu opens.
- 2 Press **◀** or **▶** to highlight **SETUP**, then press **▼** or **ENTER**. The *SETUP* menu opens.

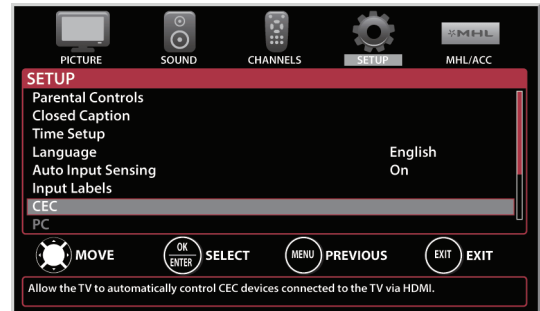

- 3 Press **▲** or **▼** to highlight **CEC**, then press **ENTER**. The *SETUP · CEC* menu opens.

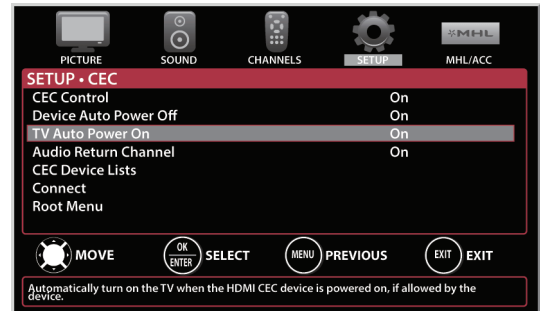

- 4 Make sure that the **CEC Control** option is turned on. See "Turning CEC Control on or off" on page 60.
- 5 On the *SETUP · CEC* menu, press **▲** or **▼** to highlight **TV Auto Power On**, then press **ENTER**.
- 6 Press **▲** or **▼** to highlight **On** (turns on your TV when you turn on the connected device) or **Off** (does not turn on your TV when you turn on the connected device), then press **ENTER**.
- 7 Press **MENU** to return to the previous menu, or press **EXIT** to close the menu.

### Turning Audio Return Channel on or off

When CEC Control is turned on and you have connected an audio receiver to your TV, turning on **Audio Return Channel** lets you use your TV's remote control to control the volume on the audio receiver.

**To turn Audio Return Channel on or off:**

- 1 Press **MENU**. The on-screen menu opens.
- 2 Press **◀** or **▶** to highlight **SETUP**, then press **▼** or **ENTER**. The **SETUP** menu opens.

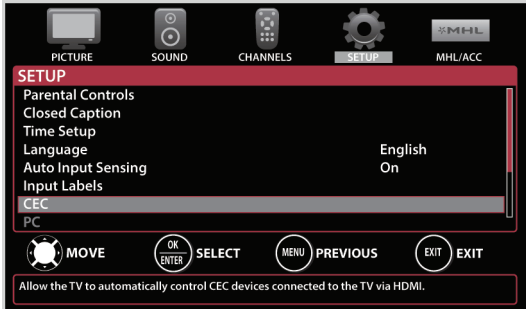

- 3 Press **▲** or **▼** to highlight **CEC**, then press **ENTER**. The **SETUP · CEC** menu opens.

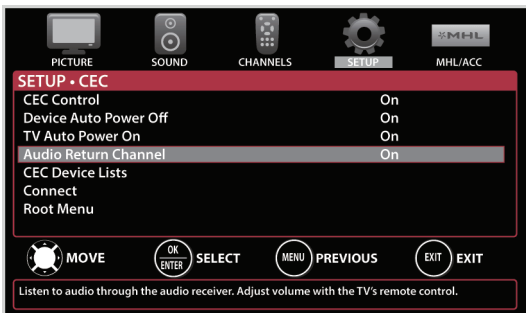

- 4 Make sure that the **CEC Control** option is turned on. See "Turning CEC Control on or off" on page 60.
- 5 On the **SETUP · CEC** menu, press **▲** or **▼** to highlight **Audio Return Channel**, then press **ENTER**.
- 6 Press **▲** or **▼** to highlight **On** (your TV's remote control controls the connected audio receiver's volume) or **Off** (your TV's remote control does not control the connected audio receiver's volume), then press **ENTER**.
- 7 Press **MENU** to return to the previous menu, or press **EXIT** to close the menu.

### Displaying a list of CEC-compatible devices

You can display a list of HDMI CEC devices that are connected to your TV.

**To display a list of CEC-compatible devices:**

- 1 Press **MENU**. The on-screen menu opens.
- 2 Press **◀** or **▶** to highlight **SETUP**, then press **▼** or **ENTER**. The **SETUP** menu opens.

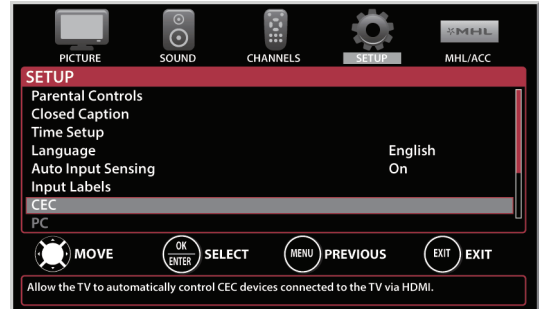

- 3 Press **▲** or **▼** to highlight **CEC**, then press **ENTER**. The **SETUP · CEC** menu opens.

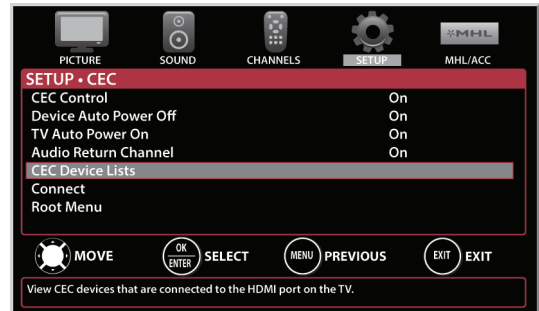

- 4 Make sure that the **CEC Control** option is turned on. See "Turning CEC Control on or off" on page 60.
- 5 On the **SETUP · CEC** menu, press **▲** or **▼** to highlight **CEC Device Lists**, then press **ENTER**. A list of the HDMI CEC-compatible devices you have connected appears.
- 6 Press **MENU** to return to the previous menu, or press **EXIT** to close the menu.

### Waking CEC-compatible devices

When a connected CEC-compatible device is in turned off (standby mode), **Connect** wakes (turns on) the device.

#### To wake CEC-compatible devices:

- 1 Press **INPUT**, press **▲** or **▼** to highlight the CEC-compatible device you want to wake, then press **ENTER**.
- 2 Press **MENU**. The on-screen menu opens.
- 3 Press **◀** or **▶** to highlight **SETUP**, then press **▼** or **ENTER**. The *SETUP* menu opens.

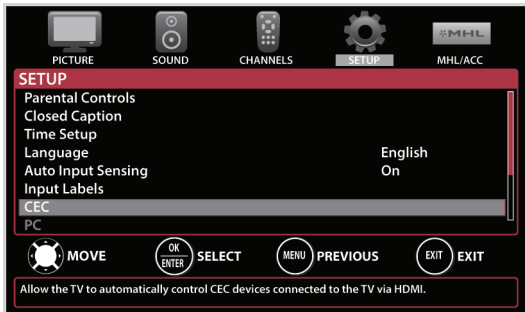

- 4 Press **▲** or **▼** to highlight **CEC**, then press **ENTER**. The *SETUP · CEC* menu opens.

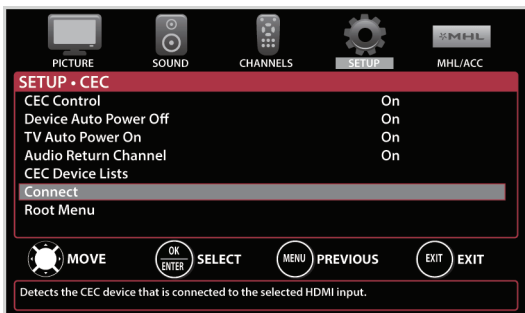

- 5 Make sure that the **CEC Control** option is turned on. See "[Turning CEC Control on or off](#)" on page 60.
- 6 On the *SETUP · CEC* menu, press **▲** or **▼** to highlight **Connect**, then press **ENTER** to wake the HDMI CEC-compatible device connected to the HDMI input you selected.
- 7 Press **MENU** to return to the previous menu, or press **EXIT** to close the menu.

### Opening a CEC-compatible device's root menu

You can open a CEC-compatible device's root menu, then use your TV's remote control to control the device, if the device has this feature.

#### To open a CEC-compatible device's root menu:

- 1 Press **INPUT**, press **▲** or **▼** to highlight the CEC-compatible device you want to control, then press **ENTER**.
- 2 Press **MENU**. The on-screen menu opens.
- 3 Press **◀** or **▶** to highlight **SETUP**, then press **▼** or **ENTER**. The *SETUP* menu opens.

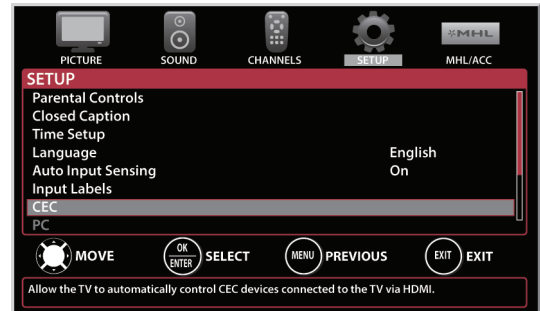

- 4 Press **▲** or **▼** to highlight **CEC**, then press **ENTER**. The *SETUP · CEC* menu opens.

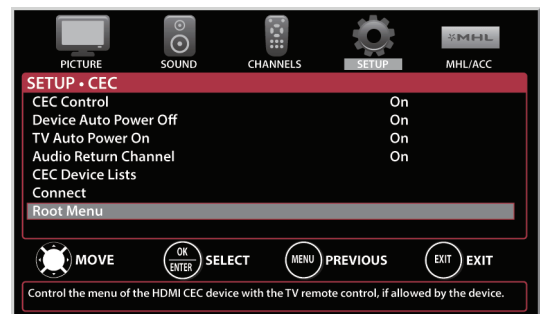

- 5 Make sure that the **CEC Control** option is turned on. See "[Turning CEC Control on or off](#)" on page 60.
- 6 On the *SETUP · CEC* menu, press **▲** or **▼** to highlight **Root Menu**, then press **ENTER**. The device's root menu opens, and you can use your TV's remote control to control the device.
- 7 Press **MENU** to return to the previous menu, or press **EXIT** to close the menu.

# Using an MHL-enabled device or Roku Streaming Stick

You can connect your MHL-enabled device, such as a cell phone or Roku Streaming Stick™, and view your device's screen on your TV.

## Using an MHL-enabled device

### To use an MHL-enabled device:

- 1 Connect an MHL-enabled device to your TV. For connection instructions, see ["Connecting an MHL-enabled device"](#) on page 24. A message tells you the device is connected.
- 2 Press **ENTER** to access your MHL-enabled device. Your device's menu opens.

**Note**  
Your device's menu will vary depending on the device and the apps you have loaded on the device.

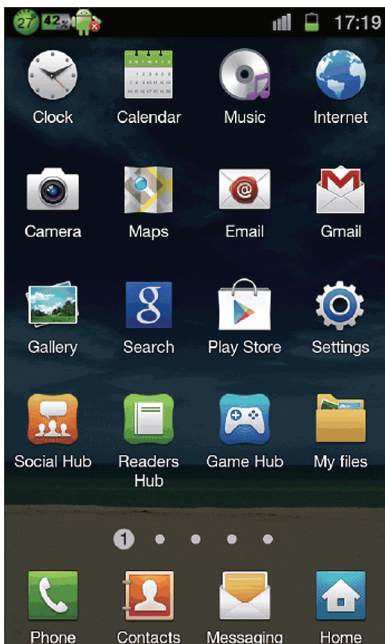

- 3 Use **▲ ▼ ◀ ▶** and **ENTER** to navigate on your device.

**Note**  
The buttons you use to navigate on your device may vary depending on the device.

### To switch to an MHL-device that is already connected:

- 1 Press **INPUT**, then press **▲** or **▼** to select **HDMI 2 (MHL/ACC)**.

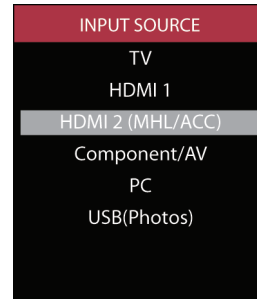

OR

- Press **MENU**, then press **◀** or **▶** to highlight **MHL/ACC**.

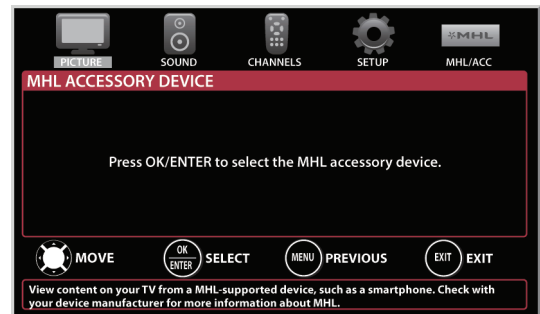

- 2 Press **ENTER** to access your MHL-enabled device. Your device's menu opens.

**Note**  
Your device's menu will vary depending on the device and the apps you have loaded on the device.

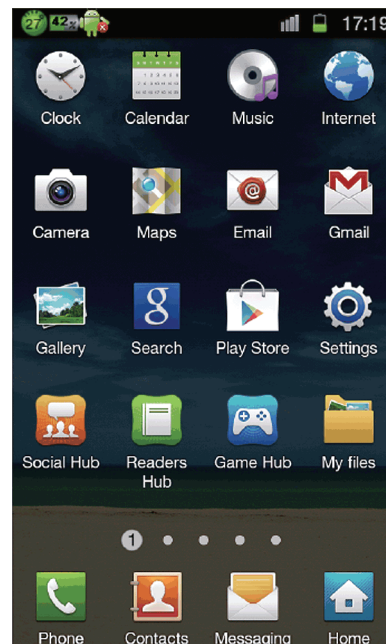

- 3 Use **▲ ▼ ◀ ▶** and **ENTER** to navigate on your device.

**Note**  
The buttons you use to navigate on your device may vary depending on the device.

## Using a Roku Streaming Stick

### To use a Roku Streaming Stick:

- 1 Connect a Roku Streaming Stick™ to your TV. For connection instructions, see “Connecting an MHL-enabled device” on page 24. A message tells you the stick is connected.
- 2 Press **ENTER** to access your Roku Streaming Stick™. Your stick’s menu opens.

**Note**

Your Roku Streaming Stick’s menu will vary depending on the content you have loaded on the device.

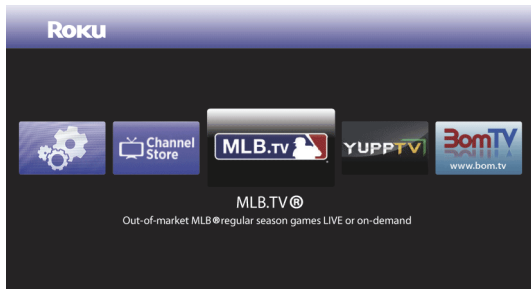

- 3 Use **▲ ▼ ◀ ▶** and **ENTER** to navigate on your Roku Streaming Stick™.

### To switch to a Roku Streaming Stick that is already connected:

- 1 Press **INPUT**, then press **▲** or **▼** to select **HDMI 2 (Roku)**.

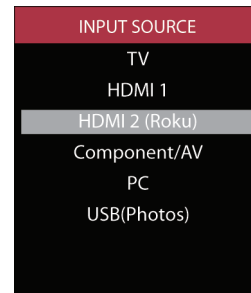

OR

Press **MENU**, then press **◀** or **▶** to highlight **Streaming**.

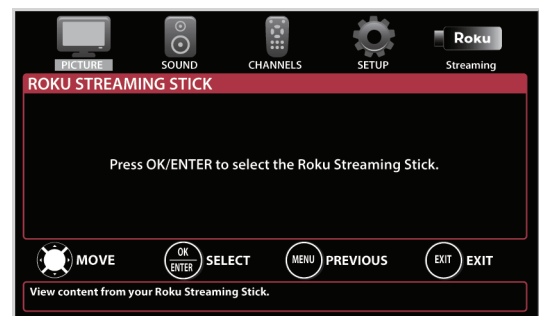

- 2 Press **ENTER** to access your Roku Streaming Stick™. Your stick’s menu opens.

**Note**

Your Roku Streaming Stick’s menu will vary depending on the content you have loaded on the device.

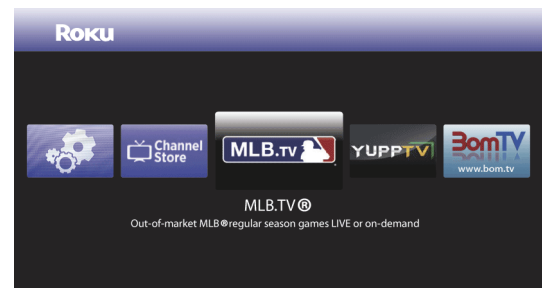

- 3 Use **▲ ▼ ◀ ▶** and **ENTER** to navigate on your Roku Streaming Stick™.



# Using a USB flash drive

You can connect a USB flash drive to your TV to view compatible JPEG pictures.

**Notes**

- Never remove the USB flash drive or turn off your TV while viewing JPEG pictures.
- The JPEG picture viewer only supports JPEG format images (with ".jpg" file extensions) and not all JPEG files are compatible with your TV.

## Switching to USB mode

**To switch to USB mode:**

- 1 Make sure that you have connected the USB flash drive to the USB port on your TV.
- 2 If your TV is turned on when you connect the USB flash drive, press **▲** or **▼** to highlight **Yes** in the message that appears, then press **ENTER**. The *PHOTOS* menu opens.

OR

If you connected the USB flash drive, then changed to a different video input source, press **INPUT** to open the *INPUT SOURCE* list, press **▲** or **▼** to highlight **USB (Photos)**, then press **ENTER**. The *PHOTOS* menu opens.

**Note**

To exit USB mode, press **INPUT** to open the *INPUT SOURCE* list, then select another input source.

## Browsing photos

**To browse photos:**

- 1 Switch to USB mode. See "Switching to USB mode" on page 66. The *PHOTOS* menu opens.

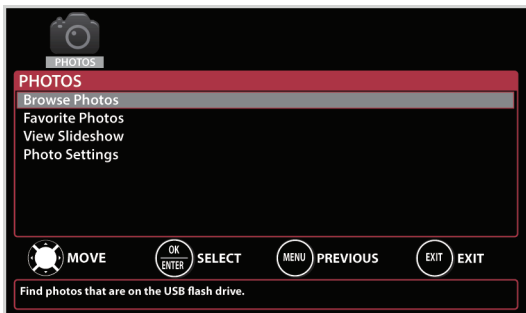

- 2 Press **▲** or **▼** to highlight **Browse Photos**, then press **ENTER**. The screen displays folder names and photo files stored on the USB flash drive in a thumbnail index with the first photo or folder highlighted. A control bar appears at the bottom of the screen.

**Note**

Photos are shown in the order they appear on the USB flash drive. They may not be listed in file name order.

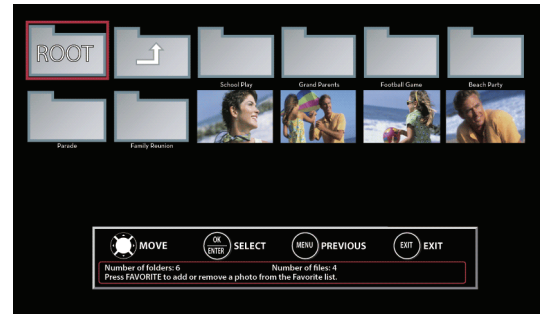

- 3 To navigate the thumbnail index screen, press:
  - **▲ ▼ ◀ ▶** to browse through the files and folders.
  - **ENTER** to view a highlighted photo full-screen or open a highlighted folder.
  - **MENU** to open the *PHOTOS* menu.
  - **FAVORITE** to add or remove a photo from the favorite photo list. A heart appears on a photo that has been added to the favorite photo list.

When a photo is displayed full-screen, a control bar appears at the bottom of the photo. The file name, picture resolution, size, and date are displayed on the bottom of the control bar. If you do not press a button within 10 seconds, the control bar closes. Press **INFO\*** to open the control bar again.

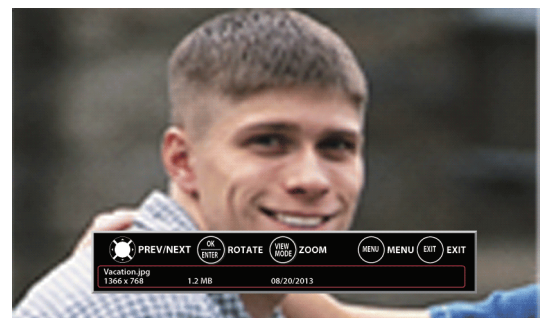

- 4 To navigate on the photo screen, press:
  - **◀** to go to the previous photo.
  - **▶** to go to the next photo.
  - **ENTER** to rotate the photo clockwise.
  - **VIEW MODE** one or more times to enlarge the image by x2 or x4 or to select **Fill** (to fill the screen). You can press **▲ ▼ ◀ ▶** to pan the photo.
  - **EXIT** to return to the thumbnail index.
  - **MENU** to return to the *PHOTOS* menu.

## Viewing favorite photos

After you create your favorite photo list, you can browse among your favorite photos quickly.

### To view favorite photos:

- 1 Switch to USB mode. See “[Switching to USB mode](#)” on page 66. The *PHOTOS* menu opens.

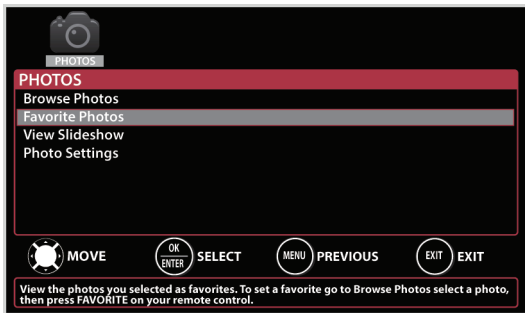

- 2 Press ▲ or ▼ to highlight **Favorite Photos**, then press **ENTER**. A thumbnail index of your favorite photos opens with a control bar at the bottom of the screen. A heart appears on a favorite photo.

#### Note

Photos are shown in the order they appear on the USB flash drive. They may not be listed in file name order.

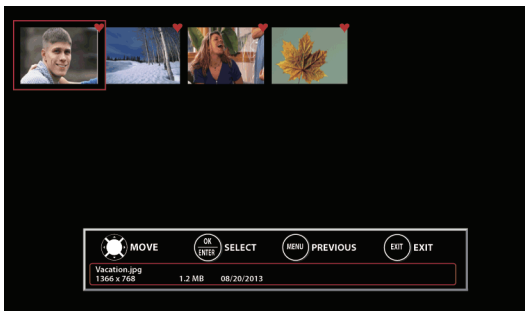

You select photos and navigate on the photo screen in the same way you do when you are browsing through photos. For more information, see “[Browsing photos](#)” on page 66.

## Viewing photos in a slideshow

You can view your photos in a slideshow.

### To view photos in a slideshow:

- 1 Switch to USB mode. See “[Switching to USB mode](#)” on page 66. The *PHOTOS* menu opens.
- 2 If the photos you want to view are in a folder on the USB flash drive, select the folder. For information about selecting a folder, see “[Browsing photos](#)” on page 66 or “[Viewing favorite photos](#)” on page 67.
- 3 Press **MENU**. The *PHOTOS* menu opens again.

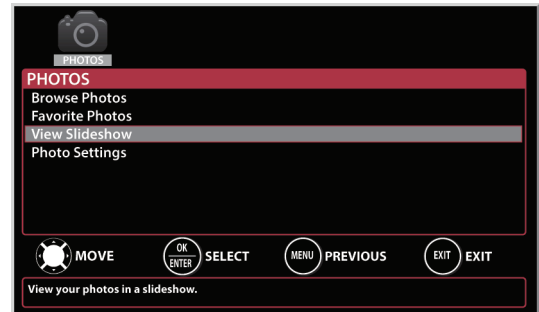

- 4 Press ▲ or ▼ to highlight **View Slideshow**, then press **ENTER**. A slideshow starts with the first photo in the current folder.
- 5 To control the slideshow, press:
  - **ENTER** to pause or start the slideshow.
  - **EXIT** to exit the slideshow and go to the *PHOTOS* menu.
  - **MENU** to go to the *PHOTOS* menu.



## Customizing slideshow settings

You can customize the slideshow settings, including **Slideshow Repeat**, **Slideshow Shuffle**, **Slideshow Interval**, and **Slideshow Effect**.

**To customize slideshow settings:**

- 1 Switch to USB mode. See "Switching to USB mode" on page 66. The *PHOTOS* menu opens.

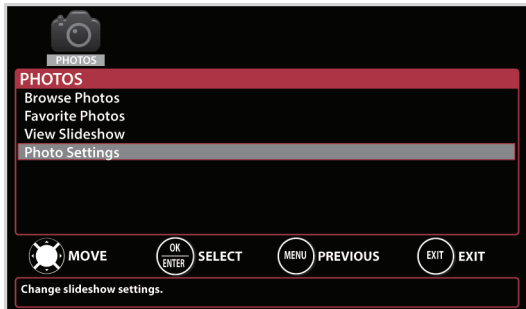

- 2 Press **▲** or **▼** to highlight **Photo Settings**, then press **ENTER**. The *PHOTOS · PHOTOS SETTINGS* menu opens.

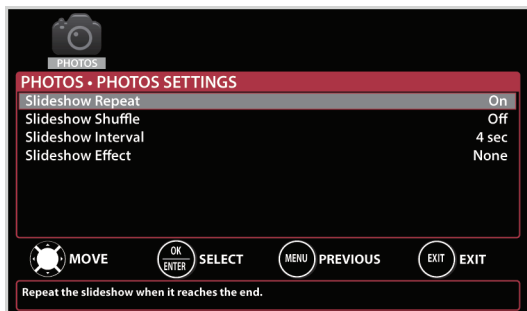

- 3 Press **▲** or **▼** to highlight an option, then press **ENTER**. You can select:
  - **Slideshow Repeat**—Repeats the slideshow when it reaches the end. You can select **On** or **Off**.
  - **Slideshow Shuffle**—Displays the slideshow photos in random order. You can select **On** or **Off**.
  - **Slideshow Interval**—Sets the amount of time a photo is displayed before the slideshow moves to the next photo. You can select **4 sec**, **6 sec**, or **8 sec**.
  - **Slideshow Effect**—Selects the way photos transition when moving to the next file in the slideshow. You can select:
    - **None**—No transition effect.
    - **Fade to Black**—Fades the screen to black between photos.
    - **Vertical Wipe**—Wipes the screen from top to bottom between photos.
    - **Horizontal Wipe**—Wipes the screen from left to right between photos.
    - **Random**—Randomly selects a transition effect.
- 4 Press **▲** or **▼** to select a setting, then press **ENTER**.
- 5 Press **EXIT** to close the menu.

## Maintaining

- Do not use your TV in areas that are too hot or too cold, because the cabinet may warp or the screen may malfunction. Your TV works best in temperatures that are comfortable to you.
- Storage temperatures are 32° to 122°F (0° to 50°C).
- Working temperatures are 41° to 104°F (5° to 40°C).
- Do not place your TV in direct sunlight or near a heat source.

### Cleaning the TV cabinet

Clean the cabinet with a soft, lint-free cloth. If the cabinet is especially dirty, moisten a soft, lint-free cloth in a weak detergent solution, squeeze the excess moisture from the cloth, then wipe the cabinet with the cloth. Use a clean cloth to dry the cabinet.

### Cleaning the TV screen

Clean the screen with a soft, lint-free cloth.

# Troubleshooting

## Warning

Do not try to repair your TV yourself.  
Contact authorized service personnel.

## Restoring settings to the defaults

When you restore default settings, all the settings you have customized (including parental controls) are reset.

### To restore settings to the defaults:

- 1 Press **MENU**. The on-screen menu opens.
- 2 Press **◀** or **▶** to highlight **SETUP**, then press **▼** or **ENTER**. The **SETUP** menu opens.

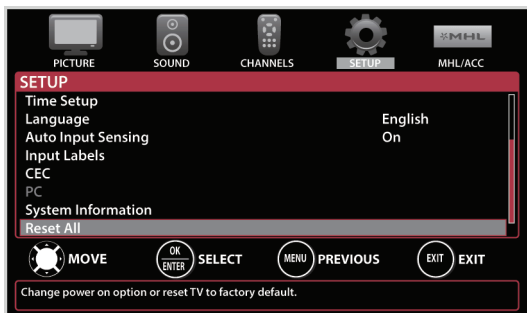

- 3 Press **▲** or **▼** to highlight **Reset All**, then press **ENTER**. The **SETUP · RESET ALL** menu opens.

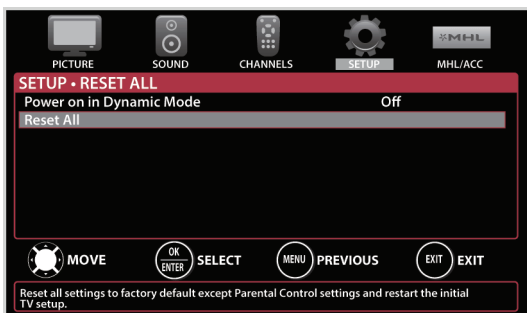

- 4 Press **▲** or **▼** to highlight **Reset All**, then press **ENTER**. A message asks if you want to reset all TV settings to the default settings.
- 5 Press **▲** or **▼** to select **OK** (to reset) or **Cancel** (to not reset), then press **ENTER**.  
If you select **OK**, the **EZ SETUP** wizard opens.
- 6 Go through the **EZ SETUP** wizard. For more information, see "Turning on your TV for the first time" on page 38.

## Viewing system information

You may need to view system information during troubleshooting.

### To view system information:

- 1 Press **MENU**. The on-screen menu opens.
- 2 Press **◀** or **▶** to highlight **SETUP**, then press **▼** or **ENTER**. The **SETUP** menu opens.

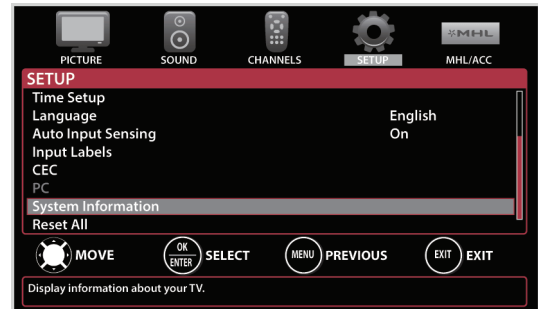

- 3 Press **▲** or **▼** to highlight **System Information**, then press **ENTER**. Information about the TV software version is displayed.
- 4 Press **MENU** to return to the previous menu, or press **EXIT** to close the menu.

### Video and audio

Problem	Solution
Picture does not fill the screen. There are black bars around the picture.	<ul style="list-style-type: none"> <li>Change the aspect ratio. An increasing amount of digital TV and movies are presented in wide screen (16:9). See View Mode option in "Adjusting the TV picture" on page 43.</li> </ul>
No picture (screen is not lit) and no sound.	<ul style="list-style-type: none"> <li>Press  on the TV or the remote control.</li> <li>Make sure that the <b>Audio Only</b> option is set to <b>Off</b>. See "Playing TV audio only" on page 47.</li> <li>Make sure that the video cables are connected securely to your TV.</li> <li>Adjust the contrast and brightness. See "Adjusting the TV picture" on page 43.</li> <li>Make sure that the power cord is plugged in.</li> <li>Make sure that the correct video input source is selected. See "Selecting the video input source" on page 40.</li> <li>Try another channel. The station may be experiencing problems.</li> <li>Make sure that the incoming signal is compatible.</li> <li>Make sure that the antenna or cable TV is connected correctly and securely. See "Connecting a cable or satellite box" on page 14 or "Connecting an antenna or cable TV (no box)" on page 19.</li> <li>Check the closed caption settings. Some TEXT modes can block the screen.</li> </ul>

Problem	Solution
Dark, poor, or no picture (screen is lit), but sound is good.	<ul style="list-style-type: none"> <li>Try another channel. The station may be experiencing problems.</li> <li>Make sure that the antenna or cable TV is connected correctly and securely. See "Connecting a cable or satellite box" on page 14 or "Connecting an antenna or cable TV (no box)" on page 19.</li> <li>Adjust the brightness. See "Adjusting the TV picture" on page 43.</li> <li>Make sure that the correct picture mode is selected. See "Adjusting the TV picture" on page 43.</li> <li>If you are using an antenna, the digital channel signal may be low. To check the digital channel signal strength, see "Checking the digital signal strength" on page 50.</li> <li>If you are using an antenna and the signal strength is low, adjust the antenna or use a highly directional outdoor antenna or set-top antenna with a built-in amplifier.</li> <li>Make sure that the video cables are connected securely to your TV.</li> <li>The video cable(s) you are using may be bad. Try a new set.</li> <li>Try another channel. The station may be experiencing problems.</li> </ul>
No color, dark picture, or color is not correct.	<ul style="list-style-type: none"> <li>Try another channel. The station may be experiencing problems.</li> <li>Adjust the color settings. See "Adjusting the TV picture" on page 43.</li> <li>Make sure that the video cables are connected correctly and securely to your TV.</li> <li>Make sure that the antenna or cable TV is connected correctly and securely. See "Connecting a cable or satellite box" on page 14 or "Connecting an antenna or cable TV (no box)" on page 19.</li> <li>If you are using an antenna, the digital channel signal may be low. To check the digital channel signal strength, see "Checking the digital signal strength" on page 50.</li> <li>If you are using an antenna and the signal strength is low, adjust the antenna or use a highly directional outdoor antenna or set-top antenna with a built-in amplifier.</li> </ul>

Problem	Solution
Only snow (noise) appears on the screen.	<ul style="list-style-type: none"> <li>• Try another channel. The station may be experiencing problems.</li> <li>• Make sure that the antenna or cable TV is connected correctly and securely. See <a href="#">“Connecting a cable or satellite box”</a> on page 14 or <a href="#">“Connecting an antenna or cable TV (no box)”</a> on page 19.</li> <li>• If you are using an antenna, the digital channel signal may be low. To check the digital channel signal strength, see <a href="#">“Checking the digital signal strength”</a> on page 50.</li> <li>• If you are using an antenna and the signal strength is low, adjust the antenna or use a highly directional outdoor antenna or set-top antenna with a built-in amplifier.</li> </ul>
Picture quality is good on some channels and poor on others. Sound is good.	<ul style="list-style-type: none"> <li>• The problem may be caused by a poor or weak signal from the broadcaster or cable TV provider.</li> <li>• If you connect to cable or satellite TV without a set-top box and experience poor picture quality, you may need to install a set-top box to improve signal reception and picture quality. Contact your cable or satellite TV provider about upgrading to a set-top box.</li> </ul>

Problem	Solution
Dotted lines or stripes appear on the screen.	<ul style="list-style-type: none"> <li>• Make sure that the antenna or cable TV is connected correctly and securely. See <a href="#">“Connecting a cable or satellite box”</a> on page 14 or <a href="#">“Connecting an antenna or cable TV (no box)”</a> on page 19.</li> <li>• If you are using an antenna, the digital channel signal may be low. To check the digital channel signal strength, see <a href="#">“Checking the digital signal strength”</a> on page 50.</li> <li>• If you are using an antenna and the signal strength is low, adjust the antenna or use a highly directional outdoor antenna or set-top antenna with a built-in amplifier.</li> <li>• Make sure that the video cables are connected securely to your TV.</li> <li>• The video cable(s) you are using may be bad. Try a new set.</li> <li>• Other devices (for example, a surround sound receiver, external speakers, fans, or hair dryers) may be interfering with your TV. Try turning off one device at a time to determine which device is causing interference. After you have determined which device is causing interference, move it further from the TV to eliminate the interference.</li> </ul>
Double images.	<ul style="list-style-type: none"> <li>• Use a highly directional outdoor antenna, cable TV, or satellite TV.</li> </ul>
The picture has a few bright or dark spots.	<ul style="list-style-type: none"> <li>• A few bright or dark spots on an LCD screen is normal. It does not affect the operation of your TV.</li> </ul>

Problem	Solution
Good picture, but no sound.	<ul style="list-style-type: none"> <li>• Increase the volume.</li> <li>• Make sure that the sound is not muted.</li> <li>• Make sure that you do not have headphones connected. When headphones are connected, no sound comes from the TV speakers.</li> <li>• Make sure that the correct audio mode is selected.</li> <li>• Make sure that the audio cables are connected correctly and securely to your TV.</li> <li>• Make sure that the antenna or cable TV is connected correctly and securely. See <a href="#">“Connecting a cable or satellite box”</a> on page 14 or <a href="#">“Connecting an antenna or cable TV (no box)”</a> on page 19.</li> <li>• If you are using an antenna, the digital channel signal may be low. To check the digital channel signal strength, see <a href="#">“Checking the digital signal strength”</a> on page 50.</li> <li>• The audio cable(s) you are using may be bad. Try a new set.</li> </ul>
Poor picture.	<ul style="list-style-type: none"> <li>• Make sure that the room is not too bright. Light reflecting off the screen can make the picture difficult to see.</li> <li>• If an S-VHS camera or a camcorder is connected while another connected device is turned on, the picture may be poor. Turn off one or more devices.</li> </ul>
Good sound, but poor color.	<ul style="list-style-type: none"> <li>• Adjust the contrast, color, and brightness settings. See <a href="#">“Adjusting the TV picture”</a> on page 43.</li> </ul>
Audio noise.	<ul style="list-style-type: none"> <li>• Other devices (for example, a surround sound receiver, external speakers, fans, or hair dryers) may be interfering with your TV. Try turning off one device at a time to determine which device is causing interference. After you have determined which device is causing interference, move it further from the TV to eliminate the interference.</li> </ul>

Problem	Solution
No output from one of the speakers.	<ul style="list-style-type: none"> <li>• Adjust the audio balance. See <a href="#">“Adjusting sound settings”</a> on page 45.</li> <li>• Make sure that the audio cables are connected correctly and securely to your TV.</li> </ul>
After images appear.	<ul style="list-style-type: none"> <li>• Do not display a still image, such as a logo, game, or computer image, for an extended period of time. This can cause a permanent after-image to be burned into the screen. This type of damage is not covered by your warranty.</li> </ul>

### Remote control

Problem	Solution
Remote control does not work.	<ul style="list-style-type: none"> <li>• Make sure that the power cord is correctly connected to your TV and a power outlet.</li> <li>• Make sure that there are no obstructions between the remote control and the remote control sensor on the front of the TV.</li> <li>• Point the remote control directly at the remote control sensor on your TV. For the location of the remote control sensor, see <a href="#">“Front”</a> on page 9.</li> <li>• The supplied batteries are wrapped tightly in clear plastic. Make sure that you have removed this plastic from the batteries.</li> <li>• Make sure that the batteries are installed correctly. See <a href="#">“Installing remote control batteries”</a> on page 37.</li> <li>• Replace dead batteries with new batteries. See <a href="#">“Installing remote control batteries”</a> on page 37.</li> </ul>

### General

Problem	Solution
No power.	<ul style="list-style-type: none"> <li>• Make sure that the power cord is correctly connected to your TV and a power outlet.</li> <li>• Unplug the power cord, wait 60 seconds, then plug the cord back in and turn on your TV.</li> <li>• Other devices (for example, a surround sound receiver, external speakers, fans, or hair dryers) may be interfering with your TV. Try turning off one device at a time to determine which device is causing interference. After you have determined which device is causing interference, move it further from the TV to eliminate the interference.</li> </ul>

Problem	Solution
"No signal" error message is displayed.	<ul style="list-style-type: none"> <li>• Press <b>INPUT</b> and make sure that you have selected the correct input for the device or service you are trying to use.</li> <li>• If you are using a cable or satellite box, use the remote that came with that box to change channels.</li> <li>• Make sure that you have the correct input selected to view channels from the cable or satellite box.</li> </ul>
After Auto Channel Search, there are no channels.	<ul style="list-style-type: none"> <li>• Reception can vary by channel depending on the broadcast power level of a given station. Contact your cable or satellite TV provider.</li> <li>• Make sure that the antenna or cable/satellite TV is connected securely to your TV.</li> <li>• Try replacing the cable between the antenna/cable or cable/satellite box and your TV.</li> </ul>
One or more channels do not display.	<ul style="list-style-type: none"> <li>• Make sure that the channels are not blocked. See "<a href="#">Setting parental control levels</a>" on page 53.</li> <li>• Make sure that the channels are not hidden. The channel may have been deleted from the channel list. You can tune to the channel by pressing the number buttons or you can add the channel back to the channel list. See "<a href="#">Hiding channels</a>" on page 49.</li> <li>• If you are using a cable or satellite box, use the remote that came with that box to change channels.</li> <li>• Make sure that you have the correct input selected to view channels from the cable or satellite box.</li> <li>• If you are using an antenna, the digital channel signal may be low. To check the digital channel signal strength, see "<a href="#">Checking the digital signal strength</a>" on page 50.</li> </ul>
Password is lost.	<ul style="list-style-type: none"> <li>• Enter <b>9999</b> to access parental controls, then set a new password. See "<a href="#">Setting or changing the password</a>" on page 51.</li> </ul>
Some settings cannot be accessed.	<ul style="list-style-type: none"> <li>• If a setting is grayed, the setting is not available in the current video input mode.</li> </ul>
TV cabinet creaks.	<ul style="list-style-type: none"> <li>• When the TV is in use, the temperature rises naturally and may cause the cabinet to expand or contract which can cause a creaking noise. This is not a malfunction.</li> </ul>

Problem	Solution
Control buttons do not work.	<ul style="list-style-type: none"> <li>• Make sure that the <b>Button Block</b> option is set to <b>Off</b>. See "<a href="#">Locking control buttons</a>" on page 52.</li> <li>• Unplug the power cord, wait a few seconds, then plug the cord back in and turn on your TV.</li> </ul>
TV keeps turning off.	<ul style="list-style-type: none"> <li>• Make sure that the sleep timer is not turned on. See "<a href="#">Setting the sleep timer</a>" on page 59.</li> </ul>
A retail banner is displayed.	<ul style="list-style-type: none"> <li>• You selected "Store" mode when you ran the EZ SETUP wizard. Reset your TV to the factory defaults, then select <b>Home</b> on the <i>What is your viewing environment</i> screen. See "<a href="#">Restoring settings to the defaults</a>" on page 69.</li> </ul>

**MHL-enabled device or Roku Streaming Stick**

Problem	Solution
The mobile device does not charge when connected to the <b>HDMI 2/MHL</b> jack.	<ul style="list-style-type: none"> <li>• Make sure that the MHL cable is connected securely to your TV and the device.</li> <li>• Make sure that you are using an MHL cable. An MHL cable may be difficult to identify. It may look like a micro USB-to-HDMI cable because the cable connectors are the same, but the cable itself is thinner. The cable also may not be labeled MHL.</li> </ul>
My TV is not displaying the video or playing the audio from the connected mobile device.	<ul style="list-style-type: none"> <li>• Make sure that the MHL cable is connected securely to your TV and the device.</li> <li>• Make sure that you are using an MHL cable. An MHL cable may be difficult to identify. It may look like a micro USB-to-HDMI cable because the cable connectors are the same, but the cable itself is thinner. The cable also may not be labeled MHL.</li> <li>• Try adjusting the picture settings on your TV.</li> <li>• Some apps may not work on your TV, depending on how the app developer programmed the app.</li> </ul>



Problem	Solution
My TV is playing the audio from a connected device but is not displaying the video.	<ul style="list-style-type: none"> <li>• Make sure that the MHL cable is connected securely to your TV and the device.</li> <li>• Make sure that you are using an MHL cable. An MHL cable may be difficult to identify. It may look like a micro USB-to-HDMI cable because the cable connectors are the same, but the cable itself is thinner. The cable also may not be labeled MHL.</li> <li>• Try adjusting the picture settings on your TV.</li> <li>• Some Apps may not work on your TV, depending on how the app developer programmed the app.</li> </ul>
My TV is displaying the video from the connected device but is not playing the audio.	<ul style="list-style-type: none"> <li>• Make sure that the volume on your mobile device is turned up and not muted.</li> <li>• Make sure that the volume on your TV is turned up and not muted.</li> <li>• Make sure that the MHL cable is connected securely to your TV and the device.</li> <li>• Make sure that you are using an MHL cable. An MHL cable may be difficult to identify. It may look like a micro USB-to-HDMI cable because the cable connectors are the same, but the cable itself is thinner. The cable also may not be labeled MHL.</li> <li>• Try adjusting the audio settings on your TV.</li> <li>• Some Apps may not work on your TV, depending on how the app developer programmed the app.</li> </ul>

### CEC-compatible device

Problem	Solution
My TV is not displaying the video from the connected CEC device.	<ul style="list-style-type: none"> <li>• Make sure that the HDMI cable is connected securely to your TV and the device.</li> <li>• Make sure that the device is connected to your TV with an HDMI cable.</li> <li>• Make sure that the device is a CEC-compatible device. See the documentation that came with the device for more information.</li> <li>• Make sure that the correct video input source is selected. See <a href="#">“Selecting the video input source”</a> on page 40.</li> <li>• Make sure that the CEC Control feature is turned on. See <a href="#">“Turning CEC Control on or off”</a> on page 60.</li> <li>• Try adjusting the TV picture. See <a href="#">“Adjusting the TV picture”</a> on page 43.</li> <li>• If the device is not a Sharp device, it may not be compatible with your TV.</li> </ul>
My TV is not playing the audio from the connected CEC device.	<ul style="list-style-type: none"> <li>• Make sure that the HDMI cable is connected securely to your TV and the device.</li> <li>• Make sure that the device is connected to your TV with an HDMI cable.</li> <li>• Make sure that the device is a CEC-compatible device. See the documentation that came with the device.</li> <li>• Make sure that the TV volume is turned up and not muted.</li> <li>• Try adjusting the TV sound. See <a href="#">“Adjusting sound settings”</a> on page 45.</li> <li>• Make sure that the TV speakers are turned on and not muted. See <a href="#">“Adjusting sound settings”</a> on page 45.</li> <li>• Make sure that the CEC control feature is turned on. See <a href="#">“Turning CEC Control on or off”</a> on page 60.</li> <li>• If you have connected an HDMI CEC audio receiver, adjust the volume on the receiver. When your TV detects an audio receiver, the TV speakers turn off and sound plays through receiver speakers only.</li> </ul>

Problem	Solution
My TV's remote control does not control the device.	<ul style="list-style-type: none"> <li>• Make sure that there are no obstructions between the remote control and the remote control sensors on your TV and the device.</li> <li>• If the device is not a Sharp device, all the buttons may not work.</li> <li>• Make sure that the CEC Control feature is turned on. See "Turning CEC Control on or off" on page 60.</li> <li>• If you are trying to control the volume on an HDMI CEC audio receiver using your TV remote control, make sure that the <b>Audio Return Channel</b> option on the CEC menu is set to <b>On</b>. See "Turning Audio Return Channel on or off" on page 62.</li> <li>• The device may not support this feature. See the documentation that came with the device for more information.</li> </ul>
The device does not show up in the CEC Device list.	<ul style="list-style-type: none"> <li>• Make sure that the device is turned on.</li> <li>• Make sure that the HDMI cable is connected securely to your TV and the device.</li> <li>• Make sure that the device is connected to your TV with an HDMI cable.</li> <li>• Make sure that the CEC Control feature is turned on. See "Turning CEC Control on or off" on page 60.</li> <li>• Make sure that the device is a CEC-compatible device. See the documentation that came with the device.</li> <li>• If the device is not a Sharp device, it may not be compatible with your TV.</li> </ul>
My device does not turn off when I turn off my TV.	<ul style="list-style-type: none"> <li>• Make sure that the CEC Control feature is turned on. See "Turning CEC Control on or off" on page 60.</li> <li>• Make sure that <b>Device Auto Power Off</b> is set to <b>On</b> on the CEC menu. See "Turning Device Auto Power Off on or off" on page 61.</li> <li>• The device may not support this feature. See the documentation that came with the device for more information.</li> </ul>

Problem	Solution
My TV does not turn on when I turn on my device.	<ul style="list-style-type: none"> <li>• Make sure that the CEC Control feature is turned on. See "Turning CEC Control on or off" on page 60.</li> <li>• Make sure that <b>TV Auto Power On</b> is set to <b>On</b> on the CEC menu. See "Turning TV Auto Power On on or off" on page 61.</li> <li>• The device may not support this feature. See the documentation that came with the device for more information.</li> </ul>
The <b>Audio Return Channel</b> setting on the CEC menu keeps turning back on after it is turned off.	<ul style="list-style-type: none"> <li>• When <b>Audio Return Channel</b> is set to <b>Off</b> and <b>CEC Control</b> is set to <b>On</b> and you adjust the volume on the audio receiver, <b>Audio Return Channel</b> is automatically set to <b>On</b>. To prevent this from happening, turn off the CEC Control feature. See "Turning CEC Control on or off" on page 60.</li> </ul>
I cannot select the <b>Root Menu</b> option on the CEC menu. OR The device's root menu does not open when I select <b>Root Menu</b> on the CEC menu.	<ul style="list-style-type: none"> <li>• The device may not support this feature. See the documentation that came with the device for more information.</li> </ul>

**Note**  
If the problem is not solved by using these troubleshooting instructions, turn off your TV, then turn it on again.



# Specifications

Specifications are subject to change without notice.

## Dimensions and weight

Without stand	44.3 × 26.3 × 2.4 in. (112.5 × 66.9 × 6.2 cm) 32 lb. (14.5 kg)
With stand	44.3 × 27.9 × 10 in. (112.5 × 70.8 × 25.5 cm) 37.3 lb. (16.9 kg)

## Screen

Screen size measured diagonally	49.5 in.
Display type	LED
Screen refresh rate	120Hz
Display resolution	1080p
Panel resolution	1920 (H) × 1080 (V)
Aspect ratio	16:9
Contrast ratio (typical)–panel	3000:1
Dynamic contrast ratio–list value	2,000,000:1
TV Brightness (minimum) cd/m <sup>2</sup>	220 nits
Comb filter	3d y/c digital
Response time	8 ms
Horizontal viewing angle	176°
Vertical viewing angle	176°

## Display resolutions

HDMI suggested resolutions	1080p, 1080i, 720p, 480p, 480i
Component video suggested resolutions	1080i, 720p, 480p, 480i

## Tuner

Analog	NTSC
Digital	ATSC, 8-VSB, Clear-QAM

## Inputs

HDMI	3 (side) E-EDID compliant HDCP compliant MHL-enabled (HDMI 2/MHL jack)
Component video	1 (back)
Composite video	1 (back) Shared with component Y
Shared audio (component and composite)	Yes
S-Video	No
PC/VGA	1 (back)
3.5mm PC audio input	1 (back)
DVI	1 (side) HDMI 3/DVI jack
USB	1 (side) Supports JPEG and firmware upgrade
Antenna/Cable	1 (back)

## Outputs

Video	No
Analog audio/Headphone	1 (side)

Digital audio	1 (optical) (back)
WiFi	No
Ethernet	No

## Audio

DTS Tuning Package	DTS Sound
Speakers	Number: 2 Watts per channel: 10W

## Power

Power consumption	On: 125W Standby: <1W
Power input	AC 120 V, 60Hz

## Miscellaneous

OSD languages	English, French, Spanish
MHL-enabled	Yes (HDMI 2/MHL jack)
ENERGY STAR qualified	Yes
Internet connectable	No
TV base screws	Stand column to TV screen: M4 type (8 mm length) (4 pcs) Base to stand column: M6 type (12 mm length) (4 pcs)
V-Chip (version 2.0)	Yes
Sleep timer	Yes
Channel labeling	Yes
VESA mount (mm) (horizontal × vertical)	400 × 400
VESA mount screws	M6 type

### Note

The length of the wall-mount screws vary depending on the wall-mount bracket you purchased. See the instructions that came with the wall-mount bracket for screw lengths.

# Programming universal remote controls

You can operate your Sharp TV with a new or existing universal remote control.

### To program a universal remote control:

- 1 See the table in "Common universal remote control codes" for common codes. If you have problems programming your remote or need a different remote control code, see the instructions that came with the remote control or check the remote control manufacturer's website for the latest remote control code information.
- 2 Follow your universal remote control's instructions to enter the TV code you found in Step 1.

**Tips**

- If your universal remote control has a code search feature, run a code search to identify a code that matches your TV. See your universal remote control's instructions for details.
- If your universal remote control has a "Learn" feature, you can manually program it using the Sharp TV remote to "teach" the commands one at a time. See your universal remote control's instructions for details.

For additional help and information:

- Visit the remote control manufacturer's website
- Call technical support for the universal remote control or cable/satellite company of the remote/set-top box you are trying to program.

### Common universal remote control codes

The following is a list of the most common remote control codes. Check the remote control manufacturer's website or check with your cable or satellite TV provider for the remote control code.

UNIVERSAL REMOTE TV CODES	
CABLE BOX, SATELLITE BOX, OR OTHER SET-TOP BOX	
<b>Cablevision</b>	004, 014, 019, 022, 028, 081, 127, 236, 251, 496
<b>Charter</b>	004, 014, 016, 019, 022, 023, 024, 025, 026, 027, 028, 029, 081, 0093, 127, 175, 143, 251, 236, 393, 395, 409, 496, 0039, 0093, 0165, 0386, 0491, 0688, 0689, 0851, 1917, 10093, 10165, 10386, 10688, 10851, 10818, 11602, 10818, 12360
<b>Comcast</b>	0093, 0165, 10032, 10036, 10093, 10153, 10165, 10386, 10398, 10491, 10851, 10854, 11089, 11407, 11602
<b>Cox</b>	002, 008, 049, 050, 051, 052, 070, 071, 072, 073, 098, 102, 107, 139, 166, 167, 179, 0039, 0093, 0153, 0157, 0165, 0220, 0281, 0386, 0398, 0491, 0630, 0688, 0689, 0818, 0851, 1004, 1006, 1010, 1022, 1025, 1079, 1093, 1094, 1095, 1100, 1137, 1139

UNIVERSAL REMOTE TV CODES	
<b>DirectTV</b>	10032, 10036, 10039, 10093, 10153, 10157, 10165, 10281, 10381, 10386, 10491, 10688, 10720, 10818, 10851, 10854, 11089, 11393, 11589, 11602, 11917
<b>Dish Network</b>	005, 026, 091, 105, 106, 107, 108, 128, 129, 214, 521, 526, 546, 585, 591, 605, 606, 607, 608, 628, 629, 654, 655, 658, 663, 670 702, 739, 740, 741, 803, 835, 965
<b>Time Warner</b>	016, 022, 023, 024, 025, 026, 027, 028, 029, 073, 107, 179, 251, 363, 0026, 0039, 0090, 0091, 0093, 0107, 0129, 0141, 0153, 0157, 0165, 0200, 0220, 0224, 0225, 0281, 0386, 0398, 0491, 0688, 0689, 0702, 0818, 0851, 1004, 1006, 1010, 1022, 1025, 1079, 1093, 1094, 1095, 1100, 1137, 1139, 1197, 1602
<b>TiVo</b>	0011, 0020, 0025, 0028, 0033, 0034, 0077, 0132, 0151, 0154, 0235, 0236, 0361, 0375
<b>Verizon</b>	342, 0120, 0205, 0518, 0715, 0716, 0878, 3005, 3008, 3021, 3025, 3027, 3073, 3121, 3125, 3132, 3138, 3142, 3206, 3222

UNIVERSAL REMOTE CONTROLS	
<b>One for All</b>	0039, 0093, 0157, 0165, 0386, 0688, 0689, 0818, 10093, 10818, 20048, 20848
<b>Phillips</b>	0002, 0111, 0202, 0224, 0228, 0502, 0509, 0603, 0813, 0907, 0913, 2550
<b>RCA</b>	005, 008, 018, 020, 067, 077, 083, 089, 097, 10093, 10818, 12360
<b>Sony</b>	00093, 00650, 00653, 00818, 01193, 01393, 01659

**Tips**

- The brand name is often visible on the front of the universal remote control, and the model number is often visible on the back.
- If your universal remote control isn't listed on the chart, refer to your universal remote control's instructions and try codes for the brands Orion, Emerson, Memorex, Sansui, Sylvania, or Zenith. You may need to try several codes before finding a match.

# Legal notices

## FCC Statement

This device complies with Part 15 of the FCC Rules. Operation is subject to the following two conditions: (1) this device may not cause harmful interference, and (2) this device must accept any interference received, including interference that may cause undesired operation.

This equipment has been tested and found to comply with the limits for a Class B digital device, pursuant to Part 15 of the FCC Rules. These limits are designed to provide reasonable protection against harmful interference in a residential installation. This equipment generates, uses and can radiate radio frequency energy and, if not installed and used in accordance with the instructions, may cause harmful interference to radio communications. However, there is no guarantee that interference will not occur in a particular installation. If this equipment does cause harmful interference to radio or television reception, which can be determined by turning the equipment off and on, the user is encouraged to try to correct the interference by one or more of the following measures:

- Reorient or relocate the receiving antenna.
- Increase the separation between the equipment and receiver.
- Connect the equipment into an outlet on a circuit different from that to which the receiver is connected.
- Consult the dealer or an experienced radio/TV technician for help.

## Warning

Changes or modifications not expressly approved by the party responsible for compliance could void the user's authority to operate the equipment.

## Cables

Connections to this device must be made with shielded cables with metallic RF/EMI connector hoods to maintain compliance with FCC Rules and Regulations.

## Canadian Notice

CAN ICES-3 (B)/NMB-3(B)  
Standard Television Receiving Apparatus – Appareil de réception télévision ordinaire, NORMES CANADIENNES BETS-7 / NTMR-7

## IC Statement

This device complies with Industry Canada licence-exempt RSS standard(s).

Operation is subject to the following two conditions: (1) this device may not cause interference, and (2) this device must accept any interference, including interference that may cause undesired operation of the device.

This equipment complies with IC radiation exposure limits set forth for an uncontrolled environment.

## Dolby License Notice and Trademark Acknowledgement



Manufactured under license from Dolby Laboratories. Dolby and the double-D symbol are trademarks of Dolby Laboratories.

## HDMI



The terms HDMI and HDMI High-Definition Multimedia Interface, and the HDMI Logo are trademarks or registered trademarks of HDMI Licensing LLC in the United States and other countries.

## DTS Sound™



Manufactured under license from DTS Licensing Limited. DTS, the Symbol, & DTS and the Symbol together are registered trademarks and DTS Sound is a trademark of DTS, Inc. © DTS, Inc. All Rights Reserved.

## MHL™ (Mobile High-Definition Link)



MHL and the MHL logo are trademarks or registered trademarks of MHL Licensing, LLC in the United States and other countries.

## Energy Star



Your Sharp TV is ENERGY STAR® qualified in the "Standard" mode. It meets strict energy efficiency guidelines set by the U.S. Environmental Protection Agency and Department of Energy. ENERGY STAR is a joint program of these government agencies, designed to promote energy efficient products and practices. Changes to certain features, settings, and functionalities of this TV (i.e. Picture, Sound) can increase or change the power consumption. Depending upon such changed settings, the power consumption may exceed the limits required for the ENERGY STAR qualification in the "Standard" mode.

# One-year limited warranty - Sharp Televisions

## Definitions:

Best Buy ("Warrantor") warrants to you, the original purchaser of this new Sharp-branded television ("Product"), that the Product shall be free of defects in the original manufacturer of the material or workmanship for a period of one (1) year from the date of your purchase of the Product ("Warranty Period"). For this warranty to apply, your Product must be purchased in the United States from a Best Buy Retail location or [www.bestbuy.com](http://www.bestbuy.com).

## How long does the coverage last?

The Warranty Period lasts for 1 year (365 days) from the date you purchased the Product. Your purchase date is printed on the receipt you received with the Product.

## What does this warranty cover?

During the Warranty Period, if the original manufacture of the material or workmanship of the Product is determined to be defective by an authorized Warrantor repair center or store personnel, Warrantor will (at its sole option): (1) repair the Product with new or rebuilt parts; or (2) replace the Product at no charge with new or rebuilt comparable products or parts. Products and parts replaced under this warranty become the property of Warrantor and are not returned to you. If service of Products or parts are required after the Warranty Period expires, you must pay all labor and parts charges. This warranty lasts as long as you own your Sharp Product during the Warranty Period. Warranty coverage terminates if you sell or otherwise transfer the Product.

## How to obtain warranty service?

If you purchased the Product at a Best Buy Retail store location or [www.bestbuy.com](http://www.bestbuy.com) and your television Product has a screen size of less than 42 inches, please take your original receipt and the Product to a Best Buy Retail store. Make sure that you place the Product in its original packaging or packaging that provides the same amount of protection as the original packaging.

To obtain in-home warranty service for a television with a screen 42 inches or larger, call 1-855-544-2030 or 1-888-BESTBUY. Call agents will diagnose and correct the issue over the phone or will have a Warrantor-approved repair technician dispatched to your home.

## Where is the warranty valid?

This warranty is valid only in the United States at Best Buy Retail stores or [www.bestbuy.com](http://www.bestbuy.com) to the original purchaser of the product.

## What does the warranty not cover?

This warranty does not cover:

- Customer instruction/education
- Installation
- Set up adjustments
- Cosmetic damage
- Damage due to acts of God, such as power surges
- Accident(s)
- Misuse, unintentional or intentional
- Abuse, unintentional or intentional
- Negligence
- Commercial purposes/use, including but not limited to use in a place of business or in communal areas of a multiple dwelling condominium or apartment complex, or otherwise used in a place of other than a private home.
- Modification of any part of the Product, including the antenna
- Damage due to incorrect operation or maintenance
- Connection to an incorrect voltage or power supply
- Outages, static or other problems with over-the-air reception of the television broadcast signals.
- Attempted repair by any person not authorized by Warrantor to service the Product
- Products sold "as is" or "with all faults"
- Consumables, including but not limited to batteries (i.e. AA, AAA, C etc.)
- Products where the factory applied serial number has been altered or removed
- Loss or Theft of this product or any part of the product

- Failures or Damage caused by any contact including but not limited to liquids, gels or pastes.
- Up to three (3) pixel failures (dots that are dark or incorrectly illuminated) grouped in an area smaller than one tenth (1/10) of the display size or up to five (5) pixel failures throughout the display. (Pixel based displays may contain a limited number of pixels that may not function normally.)
- Problems with delay in motion or action of video images while playing first-person style video games.

REPAIR REPLACEMENT AS PROVIDED UNDER THIS WARRANTY IS YOUR EXCLUSIVE REMEDY FOR BREACH OF WARRANTY. WARRANTOR SHALL NOT BE LIABLE FOR ANY INCIDENTAL OR CONSEQUENTIAL DAMAGES FOR THE BREACH OF ANY EXPRESS OR IMPLIED WARRANTY ON THIS PRODUCT, INCLUDING, BUT NOT LIMITED TO, LOST DATA, LOSS OF USE OF YOUR PRODUCT, LOST BUSINESS OR LOST PROFITS. WARRANTOR MAKES NO OTHER EXPRESS WARRANTIES WITH RESPECT TO THE PRODUCT, ALL EXPRESS AND IMPLIED WARRANTIES FOR THE PRODUCT, INCLUDING, BUT NOT LIMITED TO, ANY IMPLIED WARRANTIES OF AND CONDITIONS OF MERCHANTABILITY AND FITNESS FOR A PARTICULAR PURPOSE, ARE LIMITED IN DURATION TO THE WARRANTY PERIOD SET FORTH ABOVE AND NO WARRANTIES, WHETHER EXPRESS OR IMPLIED, WILL APPLY AFTER THE WARRANTY PERIOD. SOME STATES, PROVINCES AND JURISDICTIONS DO NOT ALLOW LIMITATIONS ON HOW LONG AN IMPLIED WARRANTY LASTS, SO THE ABOVE LIMITATION MAY NOT APPLY TO YOU. THIS WARRANTY GIVES YOU SPECIFIC LEGAL RIGHTS, AND YOU MAY ALSO HAVE OTHER RIGHTS, WHICH VARY FROM STATE TO STATE OR PROVINCE TO PROVINCE.

Product information [www.sharppusa.com](http://www.sharppusa.com)

Product support (855) 544-2030

This product is manufactured for Best Buy China Ltd., as trustee for Best Buy China, and distributed and warranted by Best Buy Purchasing, LLC (7601 Penn Avenue South, Richfield, Minnesota, U.S.A. 55423-3645) under brand license by SHARP Corporation.

©2013 Best Buy China LTD. All rights reserved.

SHARP is a registered trademark of Sharp Corporation; used under license by SHARP Corporation. All other trademarks are property of their respective owners.

# SHARP®

Product information [www.sharppusa.com](http://www.sharppusa.com)  
Product support (855) 544-2030

This product is manufactured for Best Buy China Ltd, as trustee for Best Buy China, and distributed and warranted by Best Buy Purchasing, LLC  
(7601 Penn Avenue South, Richfield, Minnesota, U.S.A. 55423-3645) under brand license by SHARP Corporation.  
©2013 Best Buy China LTD. All rights reserved.

SHARP is a registered trademark of Sharp Corporation; used under license by SHARP Corporation .  
All other trademarks are property of their respective owners.



V2 ENGLISH  
13-0436